



PTZ Network Camera User Manual

V2.14

Thank you for purchasing our product. If there is any questions or requests, please do not hesitate to contact your dealer.

This manual is applicable to the Milesight H.265 Network Camera, series are shown as follows, except where otherwise indicated.

Milesight H.265 PTZ Network Camera			
Type Megapixel	2MP	5MP	8MP
Speed Dome Network Camera	MS-C2942-(R)(P)B	MS-C5342-(H)(P)B	-
Speed Dome Network Camera II	MS-C2841-X36R(P)B/ MS-C2941-X23R(P)B/ MS-C2941-X30R(P)B/ MS-C2941-X42R(P)B	MS-C5341-X23H(P)B/ MS-C5341-X30H(P)B/ MS-C5341-X42H(P)B	MS-C8241-X36(P)B
12x Mini PTZ Bullet Network Camera	MS-C2961-(R)E(P)B/ MS-C2961-(Q)(R)EL(P)B	MS-C5361-(H)E(P)B	MS-C8161-(H)E(P)B
Mini PTZ Dome Network Camera	MS-C2971-X12RPB/ MS-C2971-X23RPB	MS-C5371-X12HPB/ MS-C5371-X23HPB	-

This Manual explains how to use and manage Milesight network cameras on your network. Previous experience of networking will be of use when using the products. Please read this manual carefully before operation and retain it for future reference.

This manual may contain several technically incorrect places or printing errors, and the content is subject to change without notice. The updates will be added into the new version of this manual. We will readily improve or update the products or procedures described in the manual.

Copyright Statement

This manual may not be reproduced in any form or by any means to create any derivative such as translation, transformation, or adaptation without the prior written permission of Milesight Technology Co., Ltd (Hereinafter referred to as Milesight).

Milesight reserves the right to change this manual and the specifications without prior notice. The latest specifications and user documentation for all Milesight products are available on our official website www.milesight.com

Industry Canada ICES-003 Compliance:

This Class B digital apparatus complies with Canadian ICES-003.

Cet appareil numérique de la classe B est conforme a la norme NMB-003 du Canada.



Safety Instruction

These instructions are intended to ensure that user can use the product correctly to avoid danger or property loss. The precaution measures are divided into “Warnings” and “Cautions”

Warnings: Serious injury or death may be caused if any of these warnings is neglected.

Cautions: Injury or equipment damage may be caused if any of these cautions are neglected.

Warnings: Please follow these safeguards to prevent injury or death.	Cautions: Please follow these safeguards to prevent potential injury or material damage.



Warnings

- ◆ This installation must be conducted by a qualified service person and should strictly comply with the electrical safety regulations of the local region;
- ◆ To avoid risk of fire and electric shock, do keep the product away from rain and moisture before installed;
- ◆ Do not touch components such as heat sinks, power regulators, and processors, which may be hot;
- ◆ Source with DC 12V or AC 24V;
- ◆ Please make sure the plug is firmly inserted into the power socket;
- ◆ When the product is installed on a wall or ceiling, the device should be firmly fixed;
- ◆ If the product does not work properly, please contact your dealer. Never attempt to disassemble the camera by yourself.



Cautions

- ◆ Make sure that the power supply voltage is correct before using the camera;
- ◆ Do not store or install the device in extremely hot or cold temperatures, as well as dusty or damp locations, and do not expose it to high electromagnetic radiation;
- ◆ Only use components and parts recommended by manufacturer;
- ◆ Do not drop the camera or subject it to physical shock;
- ◆ To prevent heat accumulation, do not block air circulation around the camera;
- ◆ Laser beams may damage image sensors. The surface of image sensors should not be exposed to where a laser beam equipment is used;
- ◆ Use a blower to remove dust from the lens cover;
- ◆ Use a soft, dry cloth to clean the surface of the camera. Stubborn stains can be removed using a soft cloth dampened with a small quantity of detergent solution, then wipe dry;
- ◆ Do not use volatile solvents such as alcohol, benzene or thinners as they may damage the surface finishes;
- ◆ Save the package to ensure availability of shipping containers for future transportation.

EU Conformity Statement



2012/19/EU (WEEE directive): Products marked with this symbol cannot be disposed of as unsorted municipal waste in the European Union. For proper recycling, return this product to your local supplier upon the purchase of equivalent new equipment, or dispose of it at designated collection points. For more information see: www.recyclethis.info.



2006/66/EC (battery directive): This product contains a battery that cannot be disposed of as unsorted municipal waste in the European Union. See the product documentation for specific battery information. The battery is marked with this symbol, which may include lettering to indicate cadmium (Cd), lead (Pb), or mercury(Hg). For proper recycling, return the battery to your supplier or to a designated collection point. For more information see: www.recyclethis.info.

Table of Contents

Chapter I Product Description.....	1
1.1 Product Overview.....	1
1.2 Key Features.....	1
1.3 Hardware Overview.....	2
1.4 How to Connect to Alarm Interface.....	6
1.5 How to Connect the Water-proof Connector.....	6
1.6 System Requirements.....	7
Chapter II Network Connection.....	8
2.1 Setting the Camera over the LAN.....	8
2.1.1 Connect the Camera to the PC Directly.....	8
2.1.2 Connect via a Switch or a Router.....	8
2.2 Dynamic IP Connection.....	8
Chapter III Accessing the Network Camera.....	10
3.1 Assigning An IP Address.....	10
3.1.1 Assigning An IP Address Using Smart Tools.....	10
3.1.2 Assign An IP Address via Browser.....	13
3.2 Accessing from the Web Browser.....	16
3.2.1 Access with Plugin.....	16
3.2.2 Access without Plugin.....	18
3.3 Accessing from Milesight VMS (Video Management Software).....	23
Chapter IV System Operation Guide.....	25
4.1 Live Video.....	25
4.1.1 Operations on Live View Page.....	25
4.1.2 3D Positioning.....	27
4.1.3 Set / Call a preset / Patrol / Pattern.....	28
4.2 Playback.....	32
4.3 Local Settings.....	34
4.4 Basic Settings.....	34
4.4.1 Video.....	34
4.4.2 Image.....	36
4.4.3 Audio.....	44
4.4.4 Network.....	46
4.4.5 Date&Time.....	55
4.5 Advanced Settings.....	56
4.5.1 Alarm.....	56
4.5.2 Storage.....	65
4.5.3 Security.....	69
4.5.4 SIP.....	72
4.5.5 Smart Event.....	74
4.5.6 PTZ.....	82
4.5.7 LPR(Optional).....	89
4.5.8 Logs.....	98
4.6 System.....	100
4.7 Maintenance.....	101
4.7.1 System Maintenance.....	101
4.7.2 Auto Reboot.....	103
Chapter V Services.....	104

Chapter I Product Description

1.1 Product Overview

Milesight provides a consistent range of cost-effective and reliable network cameras to fully meet your requirements. Based on embedded Linux operating system, Milesight network cameras could be easily accessed and managed either locally or remotely with great reliability. With built-in high-performance DSP video processing modules, the cameras pride on low power consumption and high stability. They support state-of-the-art H.265/ H.264/ MJPEG video compression algorithm and industry-leading HD dual-stream technology to achieve the highest level of video image quality under the limited network resources. It is fully functional, supporting for flexible and comprehensive alarm linkage mechanism, day and night auto switch, smart PTZ control and privacy masking, etc.

In practical applications, Milesight network cameras could either work independently in the LAN, or be networked to form a powerful safety monitoring system. It is widely used in fields such as finance, education, industrial production, civil defense, health care for security's sake.

1.2 Key Features

- ✧ Up to 30x Optical Zoom for Speed Dome, 42x for Speed Dome II, 12x Optical Zoom for Mini PTZ Bullet and 23x for Mini PTZ Dome
- ✧ 360° continuous pan and 0°~ 90° (Auto Flip) tilt for Speed Dome/ Speed Dome II
- ✧ 360° continuous pan and -45°~30° tilt for Mini PTZ Bullet
- ✧ 360° continuous pan and -5°~90° (Auto Flip) tilt for Mini PTZ Dome
- ✧ 255 Preset Points, 8 Patrols and 4 Patterns
- ✧ Based on Linux OS with high reliability
- ✧ H.265/ H.264/ MJPEG video compression capability
- ✧ Support Plugin-Free mode
- ✧ Support Smart Stream
- ✧ Support ONVIF Profile S & G & T
- ✧ Support activation and set-up of the security questions for cameras(V4x.7.0.69 or above)
- ✧ Support Primary Stream/ Secondary Stream/ Tertiary Stream
- ✧ ICR filter with auto switch, true day/night
- ✧ Built-in WEB server, support IE/ Firefox/ Chrome/ Safari browser
- ✧ UPnP protocol for the easy management of IPC
- ✧ Support Milesight DDNS
- ✧ Auto Tracking, 3D Positioning, PTZ Motion, PTZ Limit, Scheduled Tasks and Auto Home function
- ✧ White LED for Mini PTZ Bullet
- ✧ Motion Detection, Privacy Masking, Network Fault Detection and ROI
- ✧ FTP upload, SMTP upload, SD card record and SIP function
- ✧ G.711/AAC audio compression capability
- ✧ Audio Input/Output and Alarm Input/Output
- ✧ Three-privilege levels of users for flexible management
- ✧ Micro SD/SDHC/SDXC card local storage support, expand the edge storage
- ✧ Local PAL/NTSC signal output

1.3 Hardware Overview

1. Speed Dome Network Camera

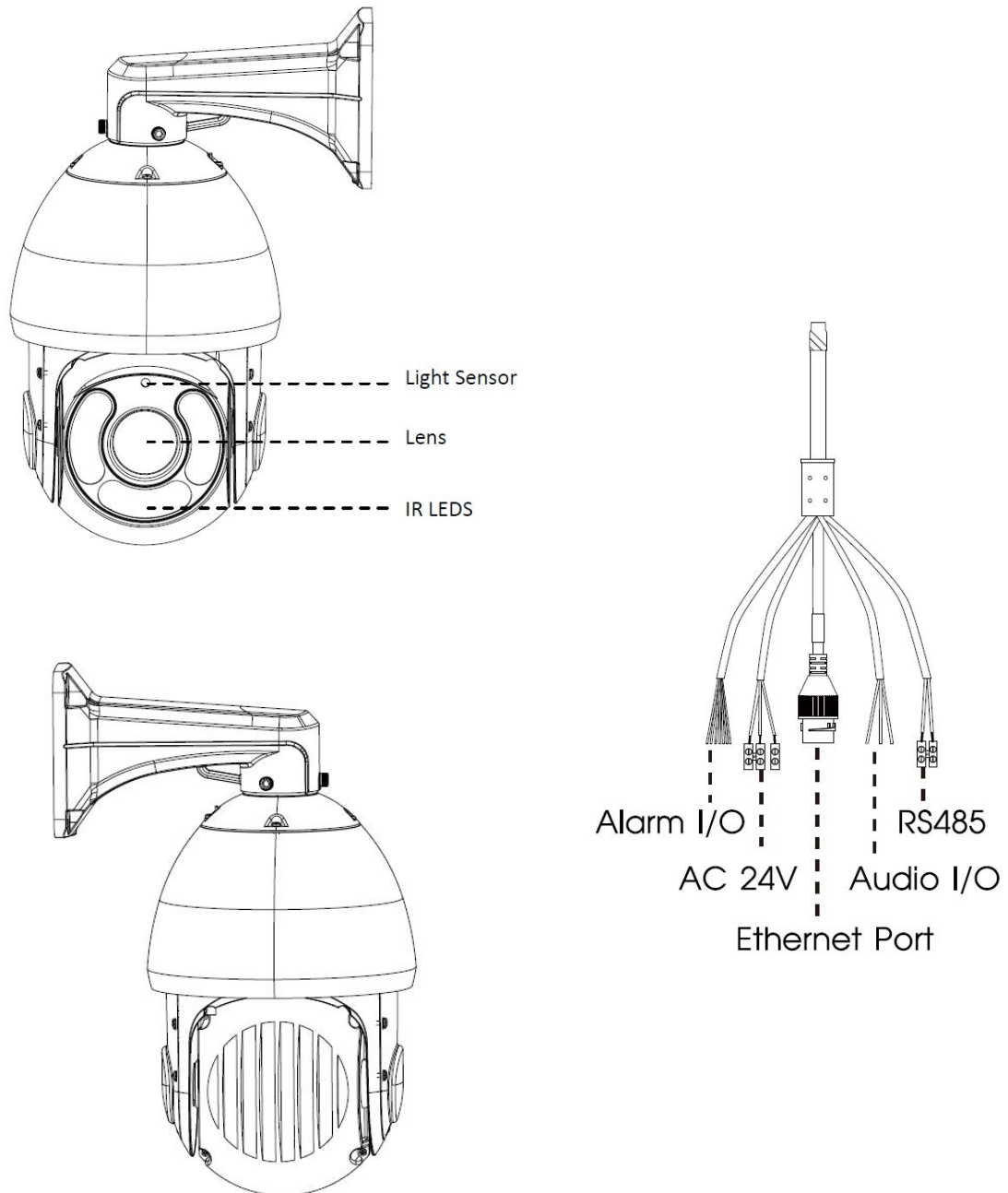

Figure 1-3-1 Speed Dome Network Camera

Note:

- 1) Only AC 24V is available for Speed Dome power supply. AC 24V and PoE (802.3at) are available for PoE Speed Dome power supply.
- 2) Reset Button: Press "Reset" button for 5 seconds, then the device will be restored to factory default.

2. Speed Dome Network Camera II

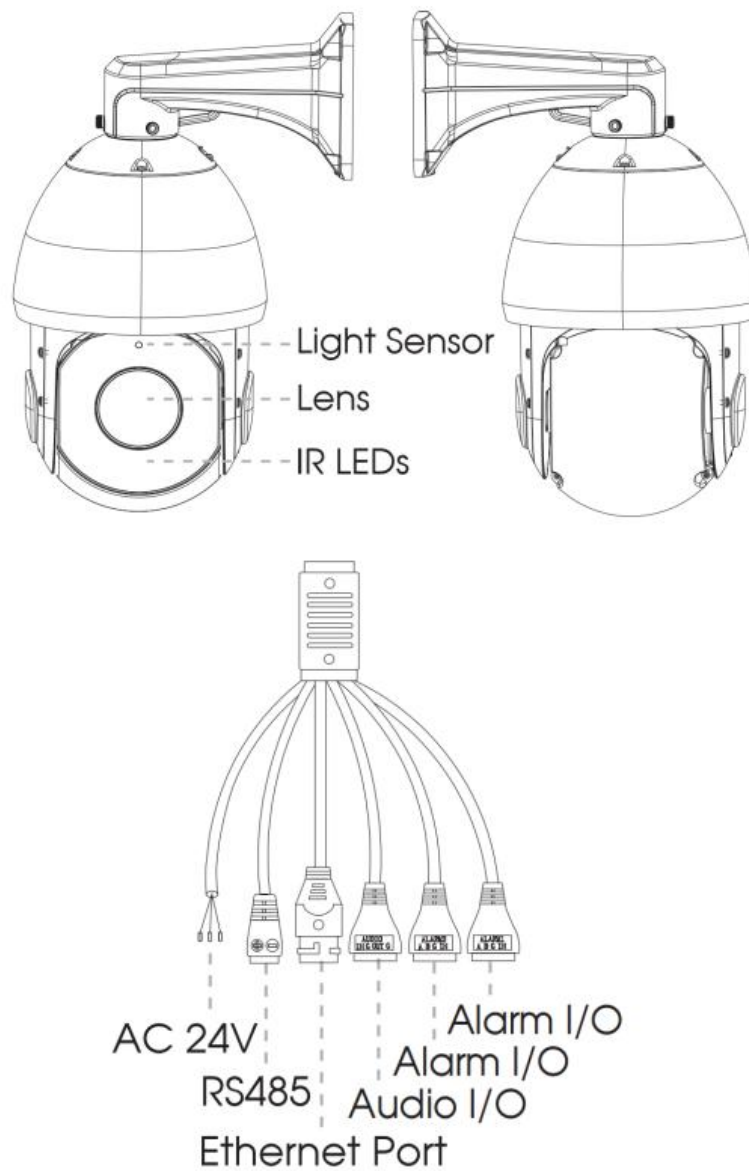

Figure 1-3-2 Speed Dome Network Camera II

Note:

- 1) Only AC 24V is available for Speed Dome II power supply. AC 24V and PoE (802.3at) are available for PoE Speed Dome II power supply.
- 2) Reset Button: Press "Reset" button for 5 seconds, then the device will be restored to factory default.

3. 12x Mini PTZ Bullet Network Camera

Wall Mount:

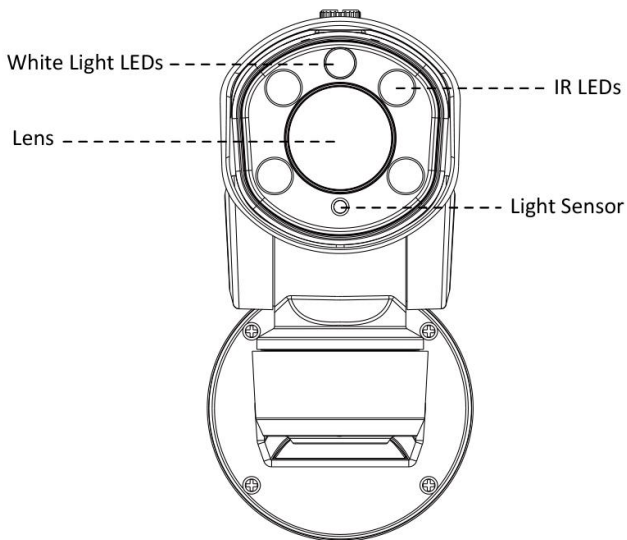

Pedestal Mount:

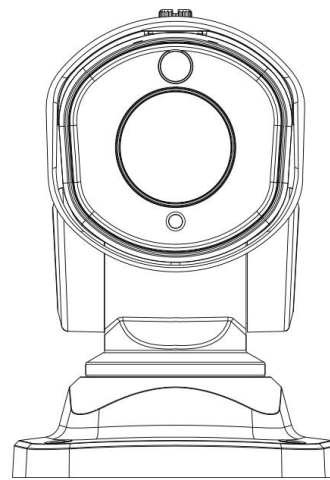

Mini PTZ Bullet:

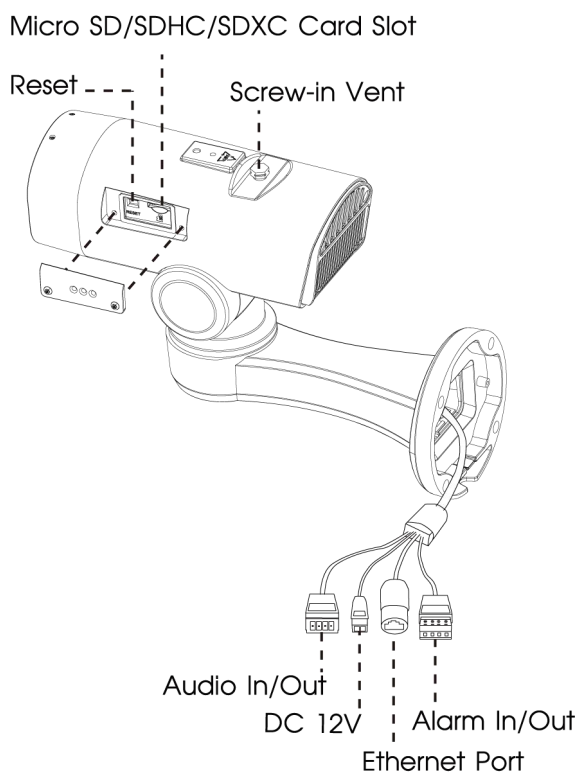

Mini PoE PTZ Bullet:

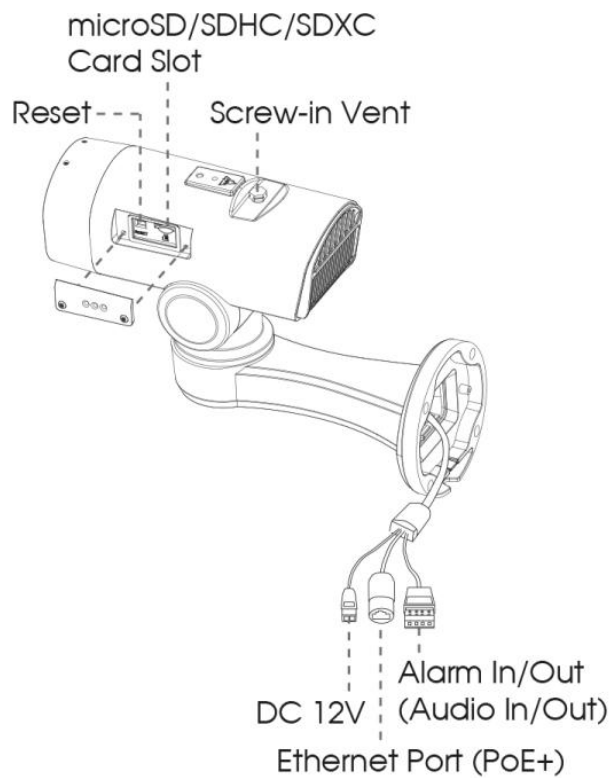

Figure 1-3-3 12x Mini PTZ Bullet Network Camera

Note:

- 1) **Reset Button:** Press “Reset” button for 5 seconds, then the device will be restored to factory default.
- 2) Only DC 12V is available for Mini PTZ Bullet power supply. DC 12V and PoE (802.3at) are available for Mini PoE PTZ Bullet power supply.

4. Mini PTZ Dome Network Camera

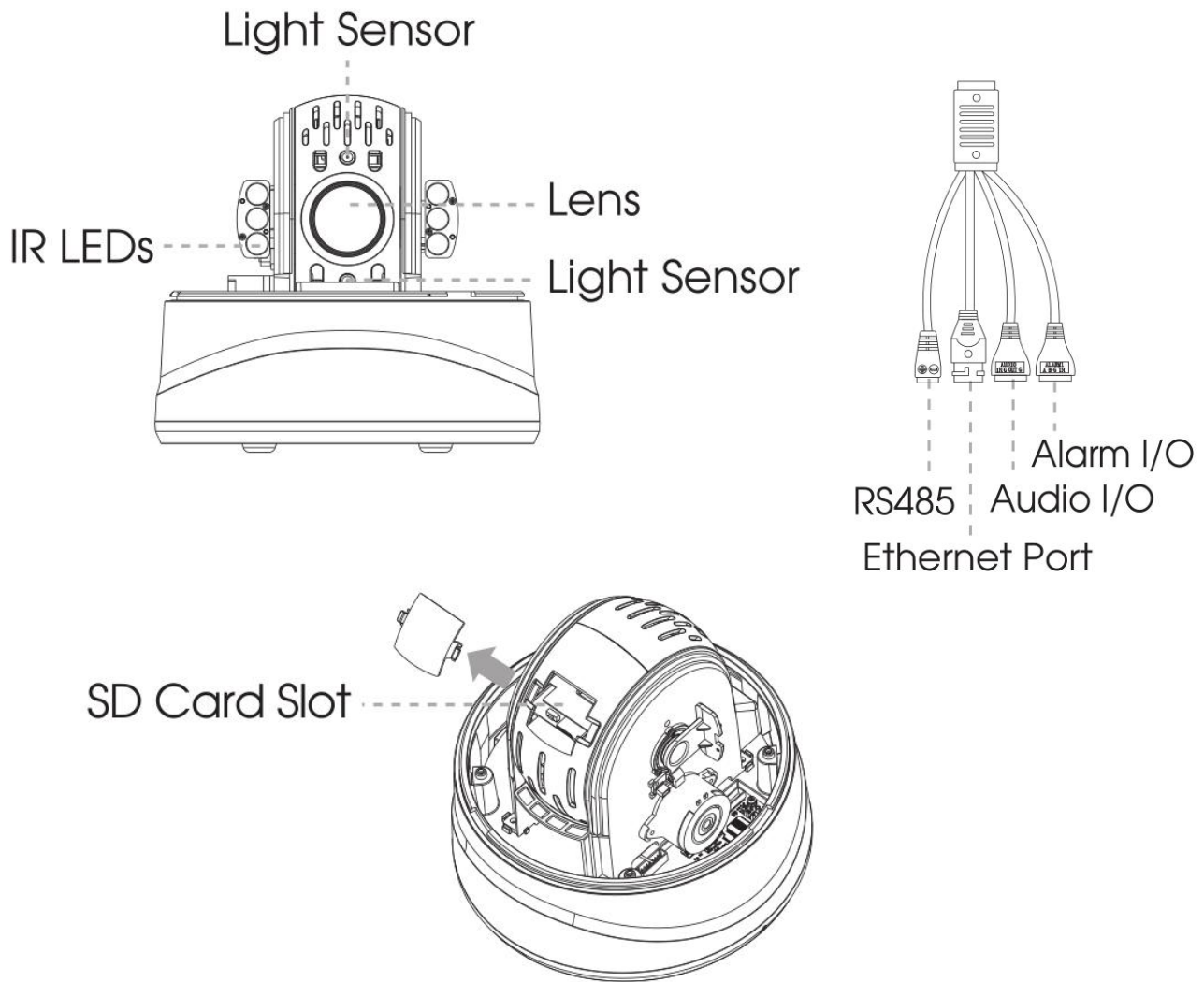

Figure 1-3-4 Mini PTZ Dome Network Camera

Note:

- 1) Reset Button: Press "Reset" button for 5 seconds, then the device will be restored to factory default.
- 2) DC 12V and PoE (802.3at) are available for power supply.

1.4 How to Connect to Alarm Interface

External interface of camera is as the following, you can refer to the picture to install the external alarm device:(Example for PTZ BULLET)

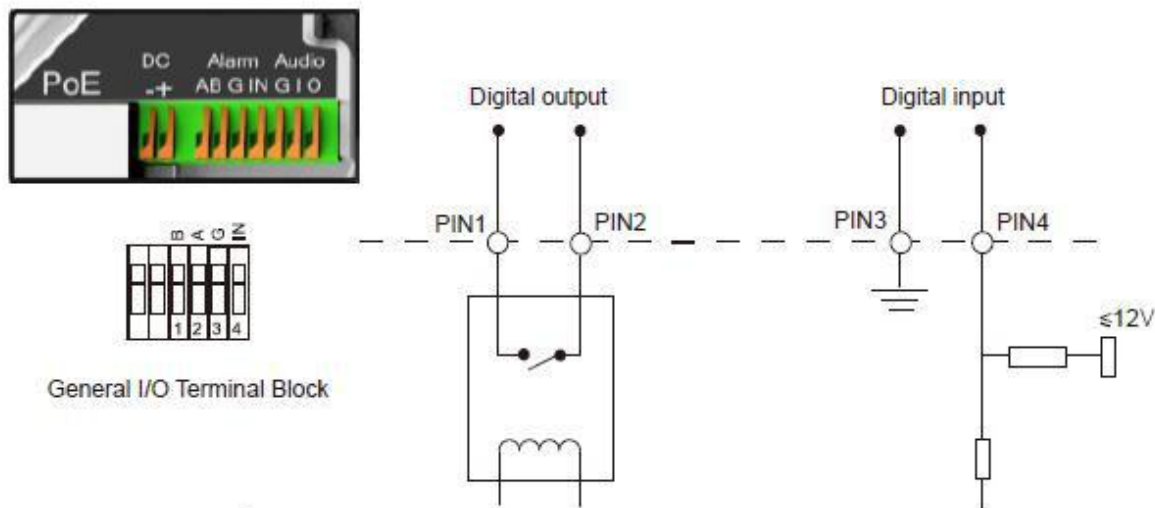

PIN1: Alarm Output NC/NO 24V DC 1A

PIN2: Alarm Output NC/NO 24V DC 1A

PIN3: Alarm Input NC/NO $\leq 12V$

PIN4: Alarm Input NC/NO $\leq 12V$

1.5 How to Connect the Water-proof Connector

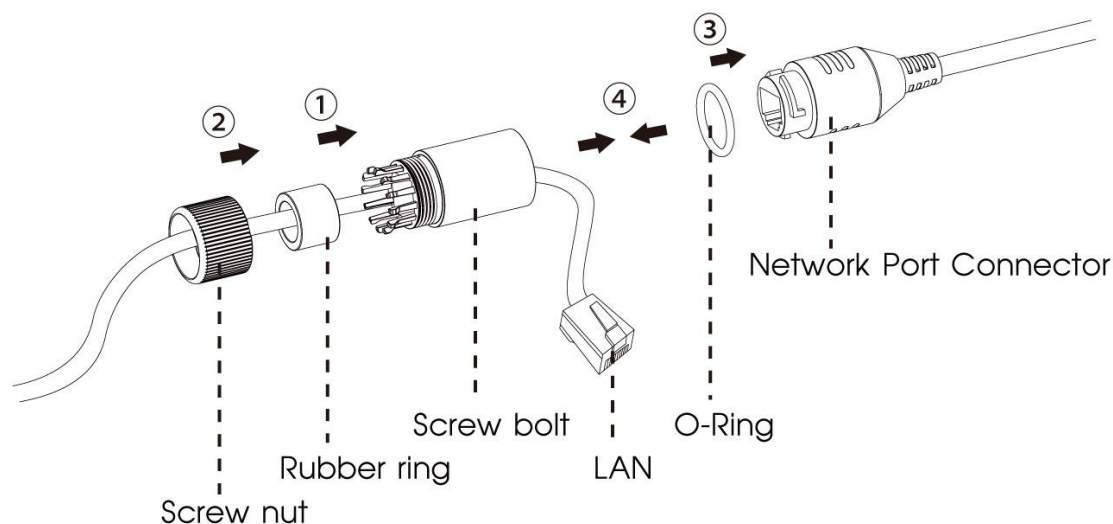

Step1: Get the network cable through the screw nut, rubber ring and the screw bolt.

Step2: Insert the rubber ring into the screw bolt.

Step3: Connect the screw nut to the screw bolt.

Step4: Place the O-Ring on the network port connector.

Step5: Connect the RJ45 to the network port connector, and tighten the screw bolt and the connector.

1.6 System Requirements

Operating System: Windows XP/Vista/7/8/10/Server 2000/Server 2008

CPU: 1.66GHz or higher

RAM: 1G or higher

Graphic memory: 128MB or more

Internet protocol: TCP/IP (IPv4/IPv6)

Web Browsers: Internet Explorer 8.0 and above version, Mozilla Firefox, Google Chrome and Safari.

Chapter II Network Connection

2.1 Setting the Camera over the LAN

Connecting the camera to a switch or a router is the most common connection method. The camera must be assigned an IP address that is compatible with its LAN.

2.1.1 Connect the Camera to the PC Directly

In this method, only when the computer connected to a camera, it will be able to view the camera. The camera must be assigned a compatible IP address to the computer. Details are shown as the following figure.

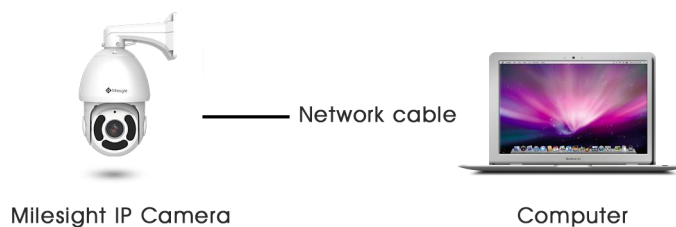

Figure 2-1-1 Connect the camera to the PC directly

2.1.2 Connect via a Switch or a Router

Set network camera over the LAN via the switch or router as figure 2-1-2:



Figure 2-1-2 Connect via a switch or a Router

2.2 Dynamic IP Connection

◆ Connecting the network camera via a router

Step1: Connect the network camera to a router;

Step2: On the camera, assign a LAN IP address, a Subnet mask and a Gateway;

Step3: On the router, set port forwarding. E.g. 80, 8000 and 554 ports. The steps for port forwarding vary depending on different routers. Please look up the router's user manual for

assistance with port forwarding;

Step4: Apply a domain name from a domain name provider;

Step5: Configure the DDNS settings in the setting interface of the router;

Step6: Visit the camera via the domain name.

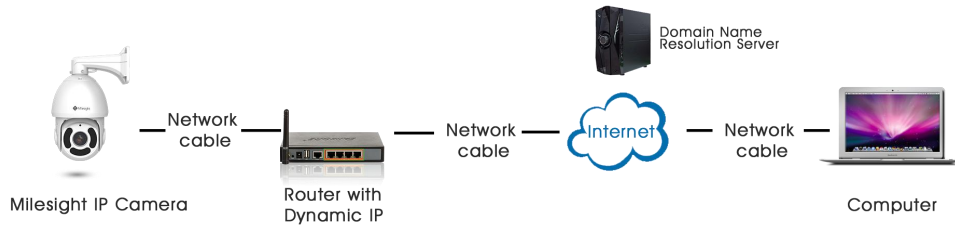

Figure 2-2 Connect the network camera via a router using dynamic IP

Chapter III Accessing the Network Camera

The camera must be assigned an IP address to be accessible.

3.1 Assigning An IP Address

The Network Camera must be assigned an IP address to be accessible. The default IP address of Milesight Network Camera is 192.168.5.190.

You can either change the IP address of the camera via Smart Tools or browser. Please connect the camera in the same LAN of your computer.

3.1.1 Assigning An IP Address Using Smart Tools

Smart Tools is a software tool which can automatically detect multiple online Milesight network cameras in the LAN, set IP addresses, and manage firmware upgrades. It's recommended to use when assigning IP addresses for multiple cameras.

Step1: Install Smart Tools (The software could be downloaded from our website);

Step2: Start Smart Tools, click the IPC Tools page, then enter the device information, such as IP address, MAC address, Status, Port number, Netmask, and Gateway, then all related Milesight network cameras in the same network that will be displayed. Details are shown as the figure below;

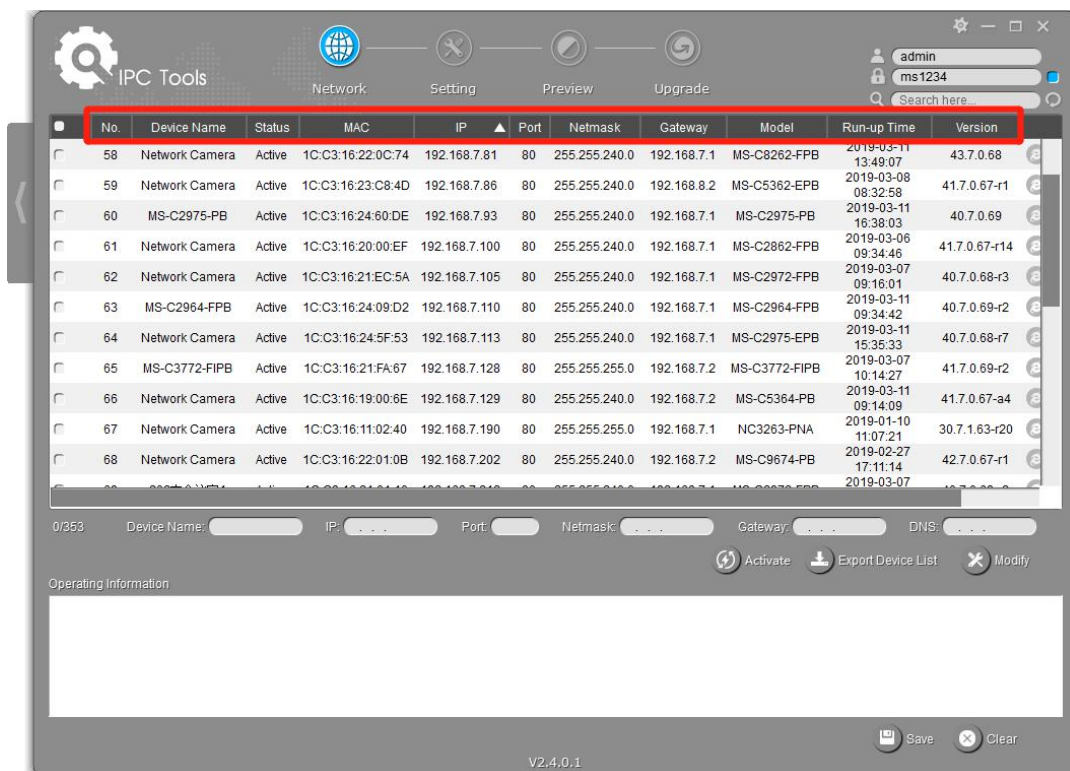

Step3: Select a camera or multiple cameras according to the MAC addresses;

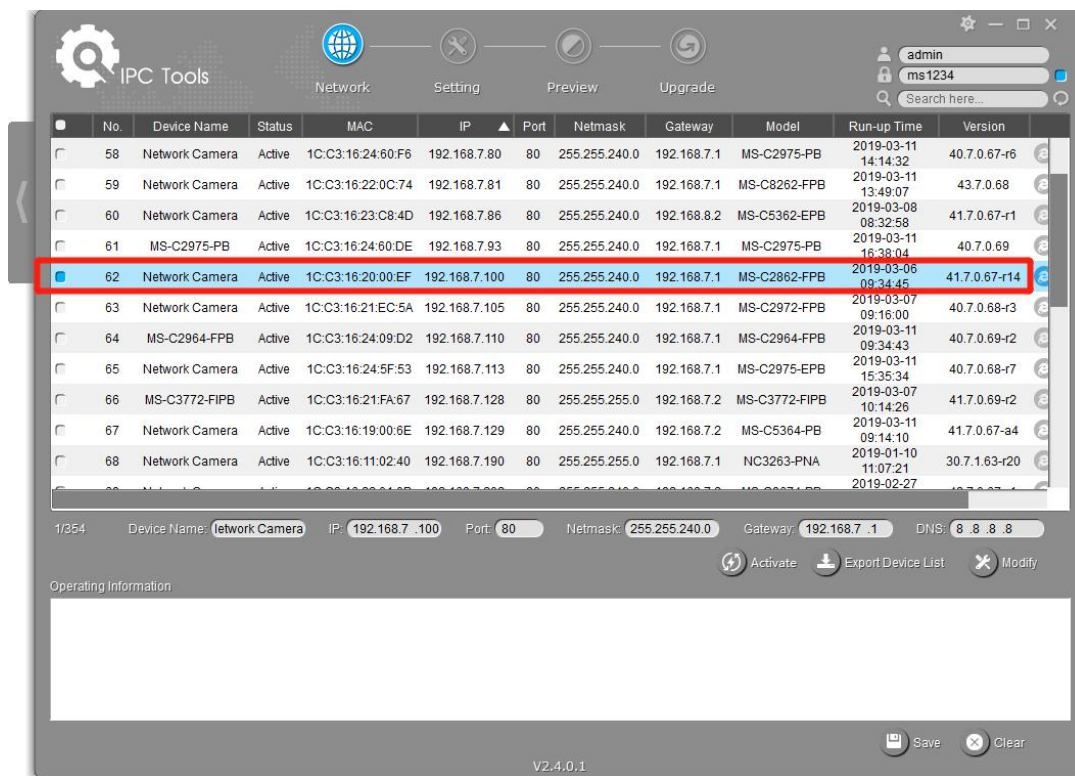

Select single camera

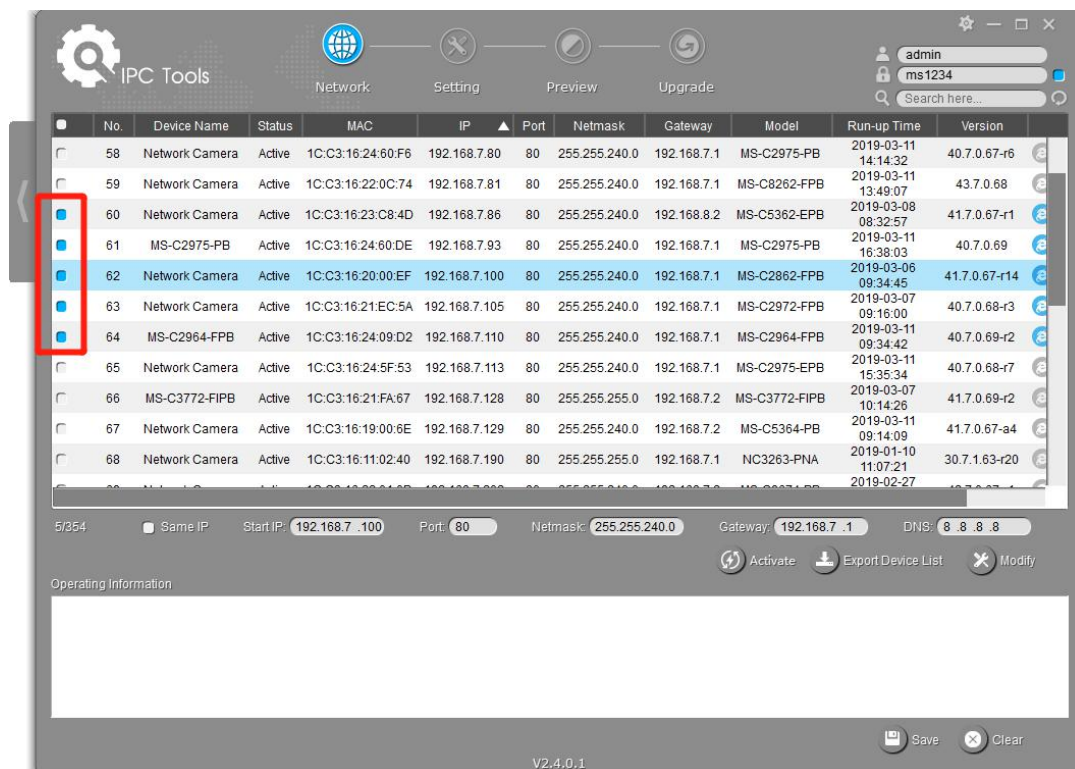

Select multiple cameras

Step4: If the selected camera shows "Active" in the status bar, you can directly type the User Name and Password (Camera with version lower than 4x.7.0.69 is using admin/ms1234 by default), change the IP address or other network values, and then click "Modify" button;

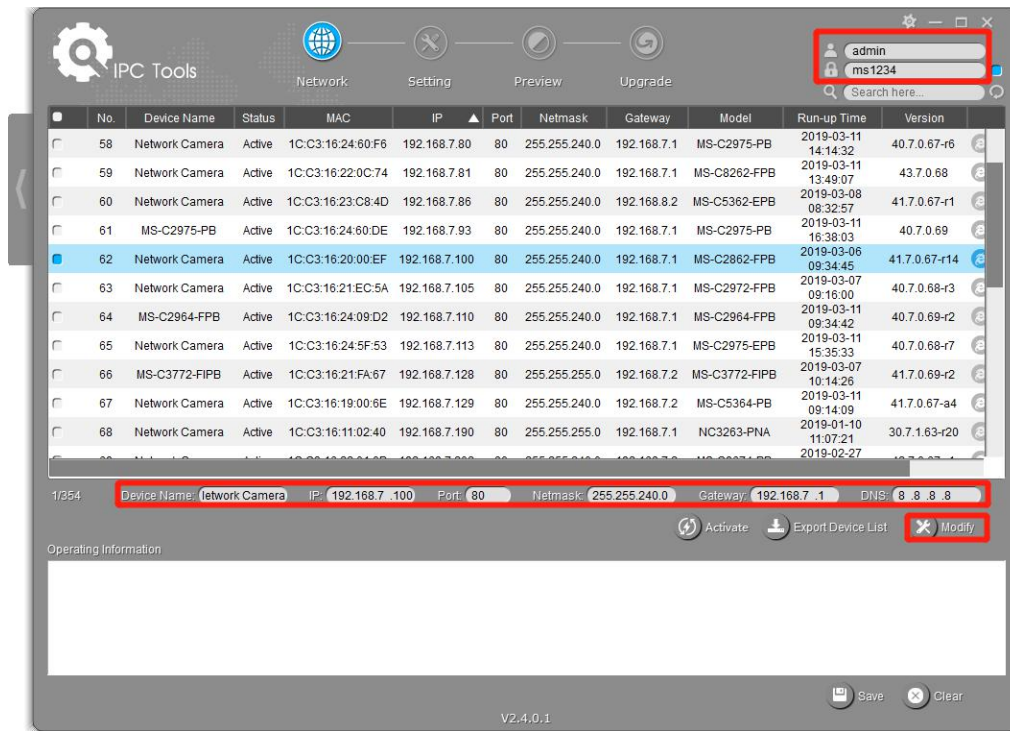

If the selected camera shows "Inactive" in the status bar(Camera with version V4x.7.0.69 or above), click to set the password when using it for the first time. You can also set the security questions when activating the camera in case that you forget the password(You can reset the password by answering three security questions correctly). Click 'Save' and it will show that the activation was successful.

Note:

- (1) Password must be 8 to 32 characters long, contain at least one number and one letter.
- (2) You need to upgrade Smart Tools version to V2.4.0.1 or above to activate the camera.

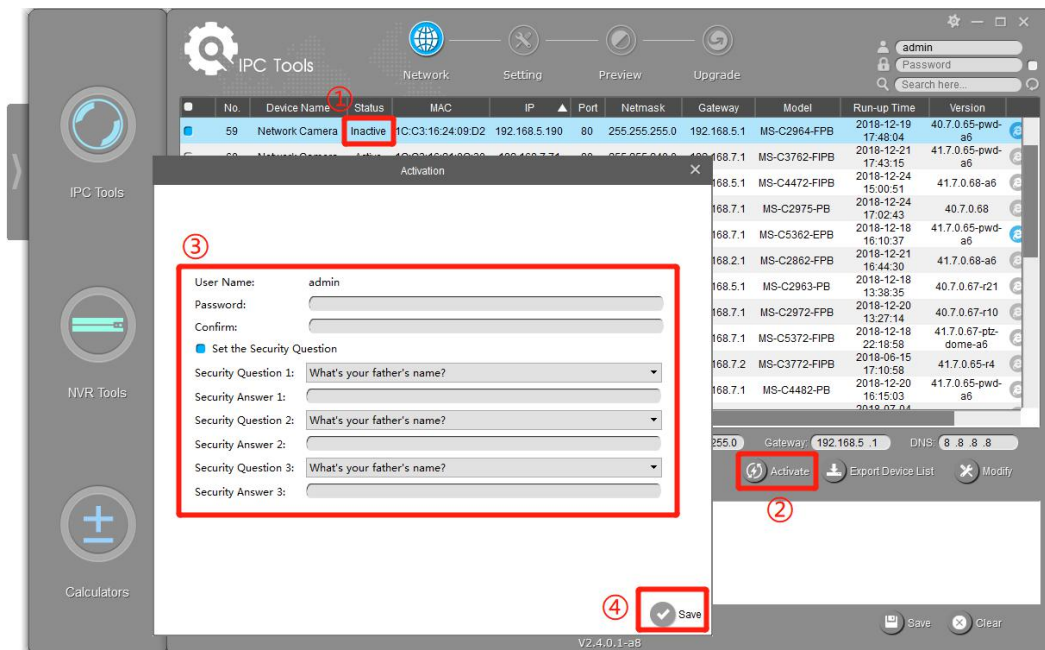

After activation, you can change the IP address or other network values, and then click "Modify" button.

Step5: Change the IP address successfully;

The screenshot displays the Milesight IPC Tools software interface. At the top, there are navigation tabs for Network, Setting, Preview, and Upgrade. A user profile for 'admin' with ID '12345678' is visible in the top right. Below the navigation is a table listing network cameras with columns for No., Device Name, Status, MAC, IP, Port, Netmask, Gateway, Model, Run-up Time, and Version. Row 61 is selected, showing a Network Camera with IP 192.168.7.114. Below the table, there are fields for Device Name (Network Camera), IP (192.168.7.114), Port (80), Netmask (255.255.240.0), Gateway (192.168.7.1), and DNS (8.8.8.8). There are buttons for Activate, Export Device List, and Modify. Below these fields is an 'Operating Information' section with a log entry: '1 2019-09-30 09:10:53 [1C:C3:16:24:09:D2] Modify IP:192.168.7.113->192.168.7.114 successfully.' The interface also includes 'Save' and 'Clear' buttons at the bottom right and a version number 'V2.4.0.1-r6' at the bottom center.

Step6: By double clicking the selected camera or the browser of interested camera, you can access the camera via web browser directly. The Internet Explorer window will pop up.



More usage of Smart Tools, please refer to the **Smart Tools User Manual**.

3.1.2 Assign An IP Address via Browser

If the network segment of the computer and that of the camera are different, please follow the

steps to change the IP address:

Step1: Change the IP address of computer to 192.168.5.0 segment, here are two ways as below:

- a. Start → Control Panel → Network and Internet Connection → Network Connection → Local Area Connection, and double click it. (Refer to Figure 3-1-8);

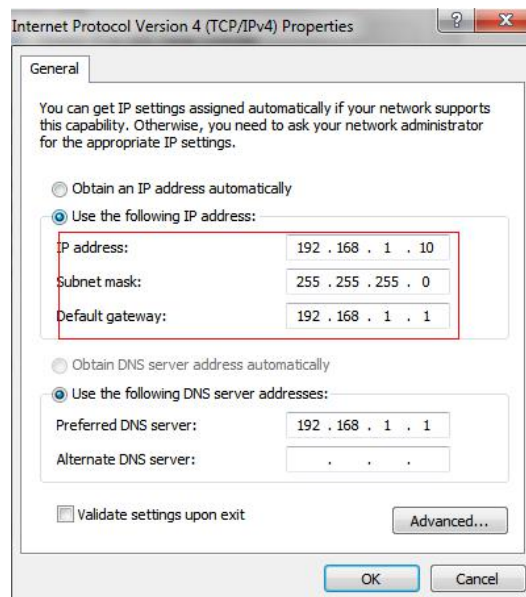

- b. Click “Advanced”, and then click “IP settings” → “IP address” → “Add” (See Figure 3-1-9). In the pop-up window, enter an IP address that in the same segment with Milesight network camera (e.g. 192.168.5.61, but please note that this IP address shall not conflict with the IP address on the existing network);

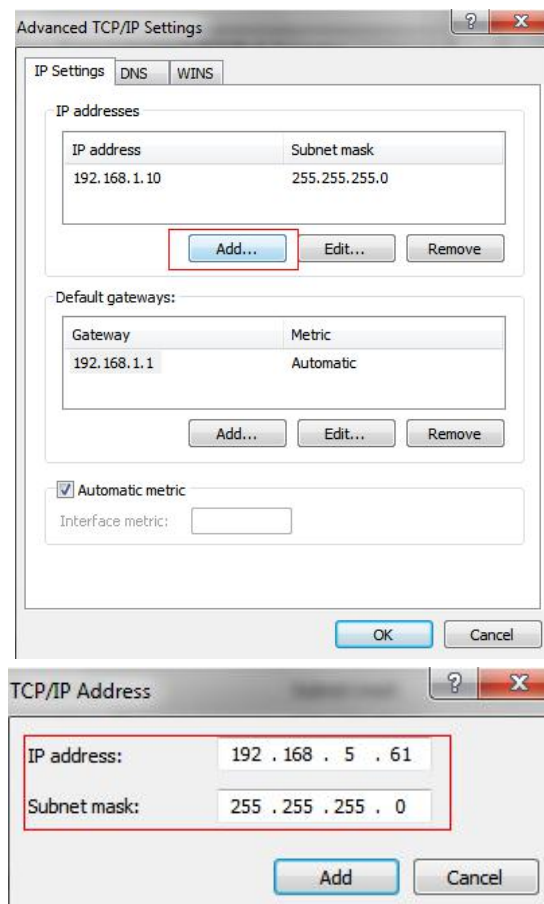

Step2: Start the browser. In the address bar, enter the default IP address of the camera:

http://192.168.5.190;

Step3: If the camera's firmware version is lower than V4x.7.0.69, it will directly display the login page, enter the user name and password when the LOGIN page appears;

Default user name: **admin**

Default password: **ms1234**

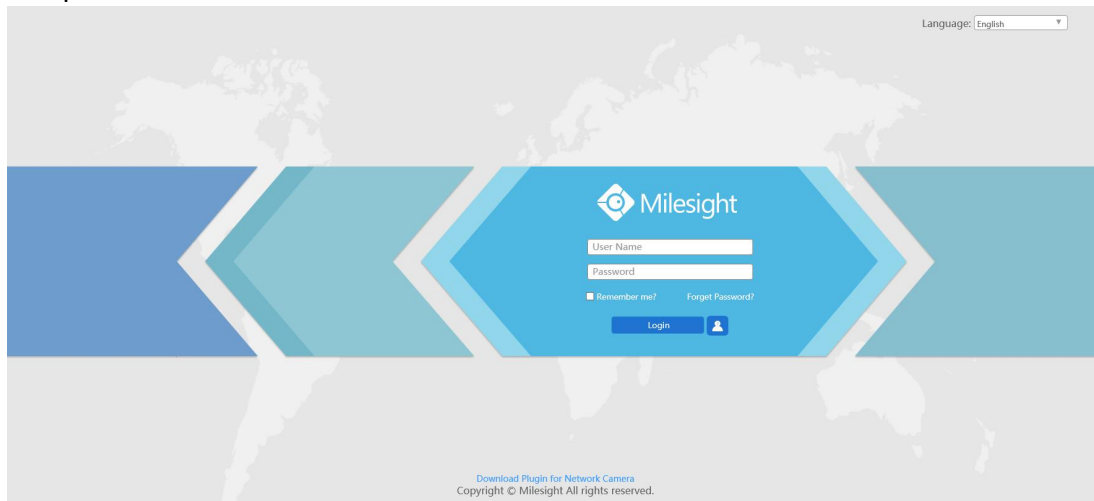

If the camera's firmware version is V4x.7.0.69 or above, you need to set the password first when using it for the first time. And you can also set three security questions for your device after activation. Then, you can log in the device with You can log in to the camera with the username(admin) and a custom password.

Note:

- (1) Password must be 8 to 32 characters long, contain at least one number and one letter.
- (2) You can click the "forget password" in login page to reset the password by answering three security questions when you forget the password, if you set the security questions in advance.

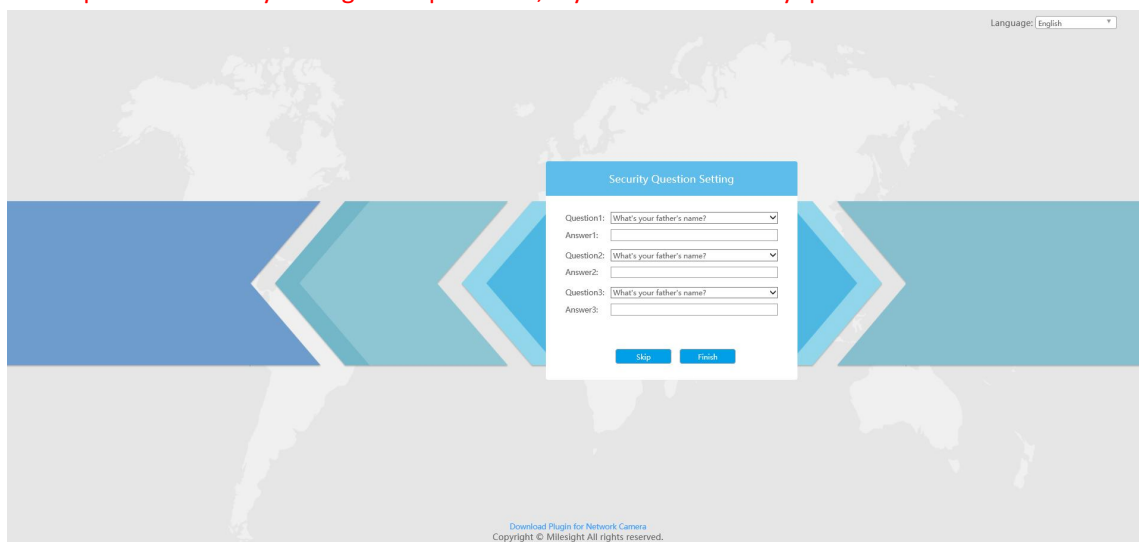

Step4: After login, please select "Configuration" → "Basic Settings" → "Network" → "TCP/IP". The Network Settings page appears (Shown as below Figure);

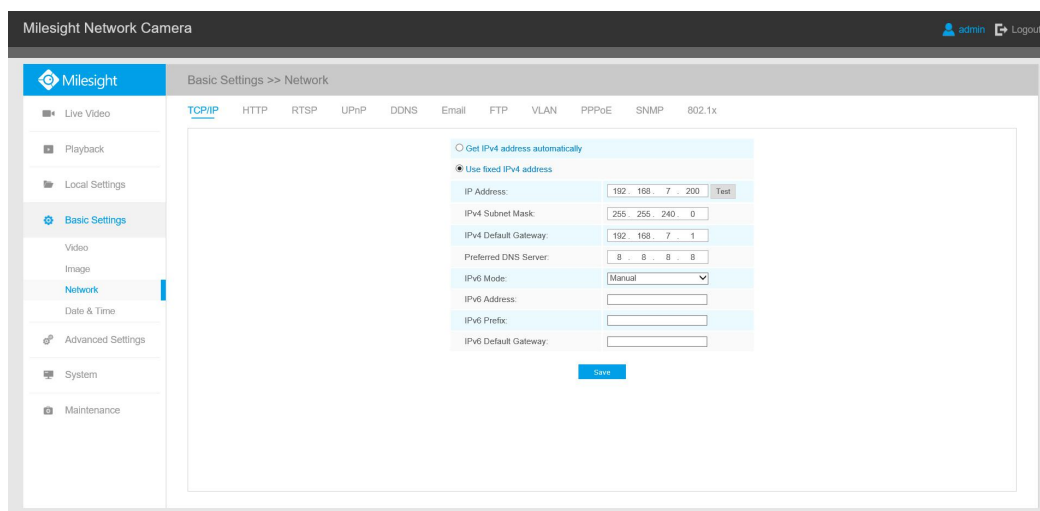

Step5: Change the IP address or other network values. Then click “Save” button;

Step6: The change of default IP address is completed.

3.2 Accessing from the Web Browser

The camera can be used with the most standard operating systems and browsers. The recommended browsers are Internet Explorer, Firefox, Chrome, Microsoft Edge, Safari.

3.2.1 Access with Plugin

Currently you can only access the camera with plugin via Internet Explorer.

Access over IE Browser

Before using the browser to get access to your camera, you need to install the MsActiveX firstly. You can refer the steps as follows:

Step1: Launch the IE browser and enter the IP address of the camera;

Step2: Enter the User Name and Password and click “Login”;

Step3: At the first time to log in the device, the browser will prompt to install Controls, please click “Click here to download and install controls manually” as shown in the figure below;



Note:

1) During installing the controls, please keep the browsers close.

Step4: Follow the prompts to install the Controls, when it`s finished, it will pop out a window as shown in the figure below. Please click “Finish” and refresh the browser, then you will see the video.

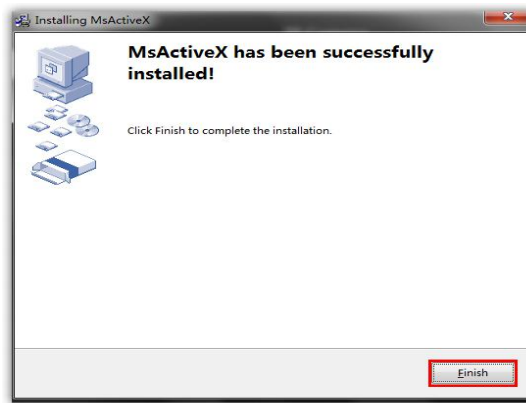

If IE9 or higher version browser is used, it is suggested that the Milesight camera web link should be added as a trusted site. See the instructions as follows:

Step1: Start the IE9 or higher version browser, and select “Tools”→ “Internet Options”;

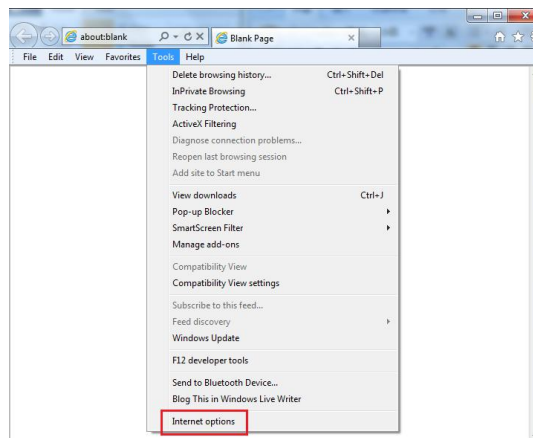
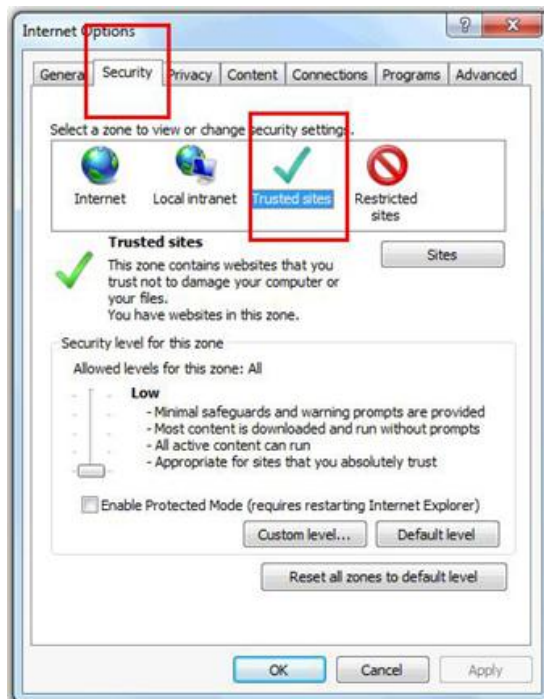
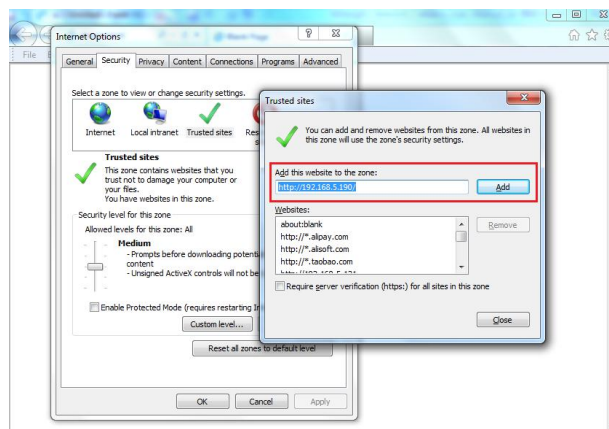

Figure 3-2-3 To add the permission

Step2: Select “Security” to “Trusted”;



Step3: Enter the IP address of the camera in the blank and click “Add”;



Step4: Enter the IP address. After logging on network camera's web GUI successfully, user is allowed to view live video as follows.

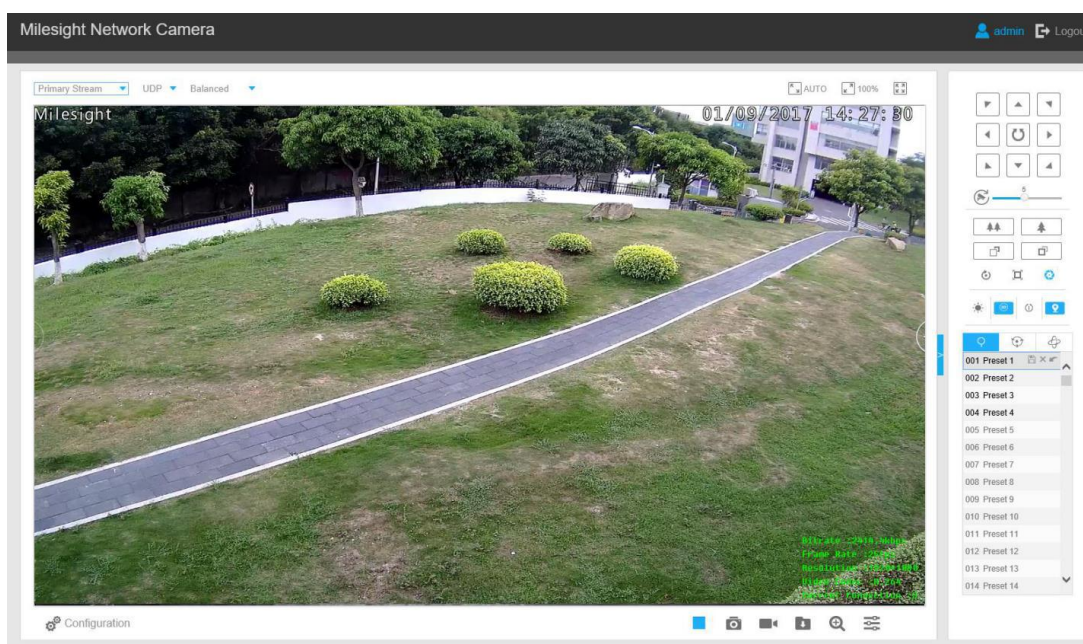

3.2.2 Access without Plugin

You can preview the video on the browser without plugin in Plugin-Free mode. Currently Plugin-Free mode is supported in Chrome and Firefox browser for Windows system, MAC system and Android system. Both H.265&H.264 video codec are supported in Plugin-Free Mode for camera, and it will play the secondary stream by default.

Note:

- ① You need to upgrade camera to V4x.7.0.70 or above to use Plugin-Free Mode.
- ② If you use Chrome browser, Plugin-Free mode is only supported when the browser version is V69 or above.
- ③ If you use Firefox browser, Plugin-Free mode is only supported when the browser version is V65 or above.

(1) On Chrome browser

Step1: Access camera via Chrome browser.

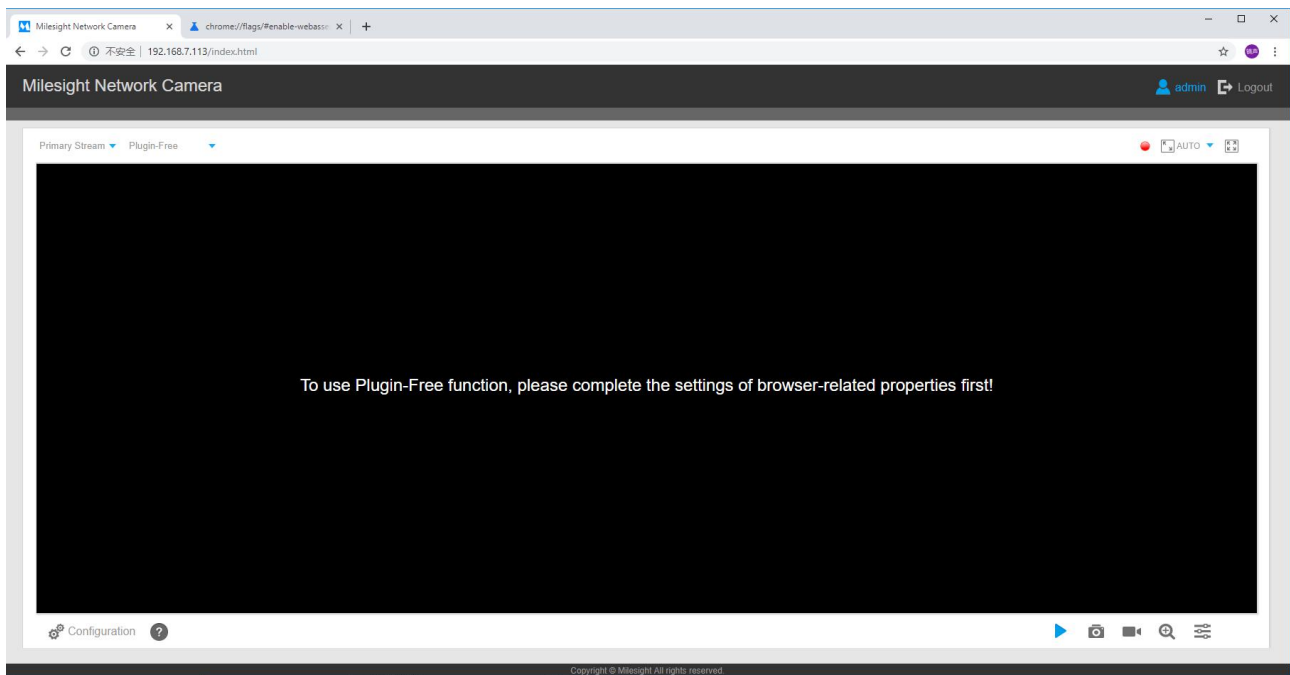

Step2: Click “” icon in the lower left corner of the webpage, you can refer to Plugin-Free Mode instruction below.

Plugin-Free Mode instruction:

Step 1:

Input the URL in address bar:

<chrome://flags/#enable-webassembly-threads>

Step 2:

Set 2 flags to True status and reboot browser:

--WebAssembly threads support.

--Experimental enabled SharedArrayBuffer support in JavaScript.

Step3: Input the URL in address bar: <chrome://flags/#enable-webassembly-threads>
You will enter the webpage shown below.

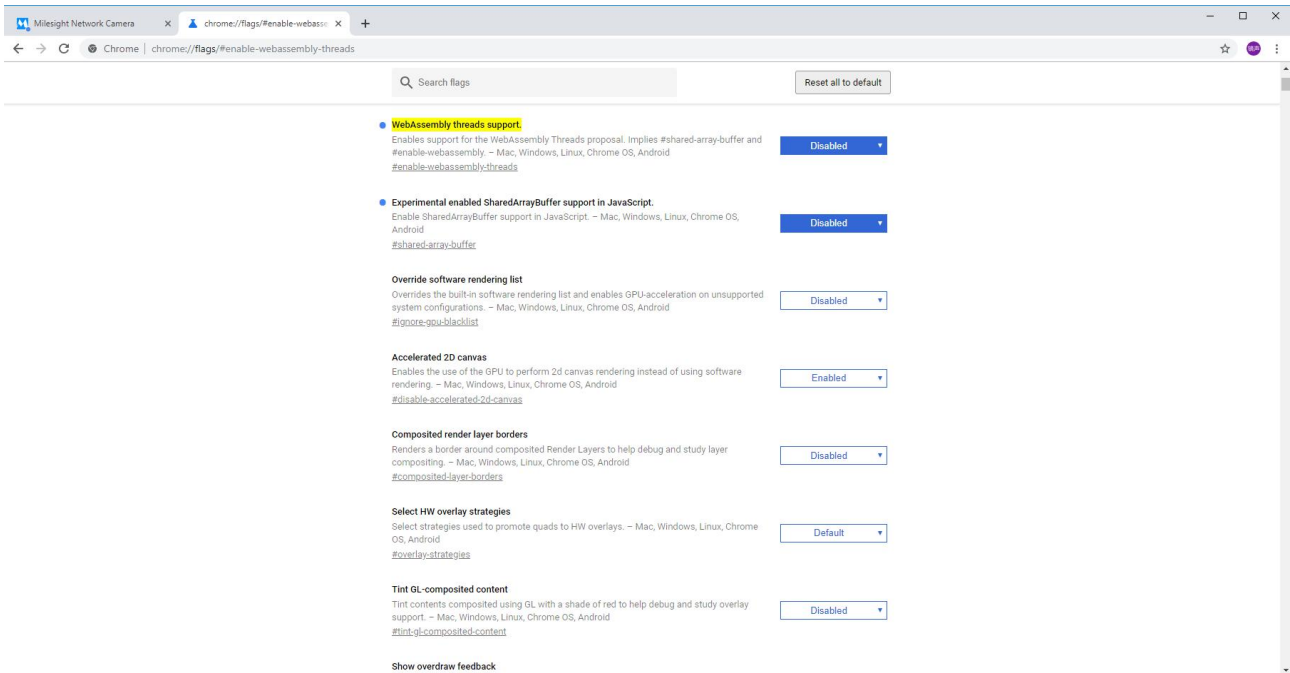

Step4: Set 2 flags to True status and reboot browser:

--WebAssembly threads support.

--Experimental enabled SharedArrayBuffer support in JavaScript

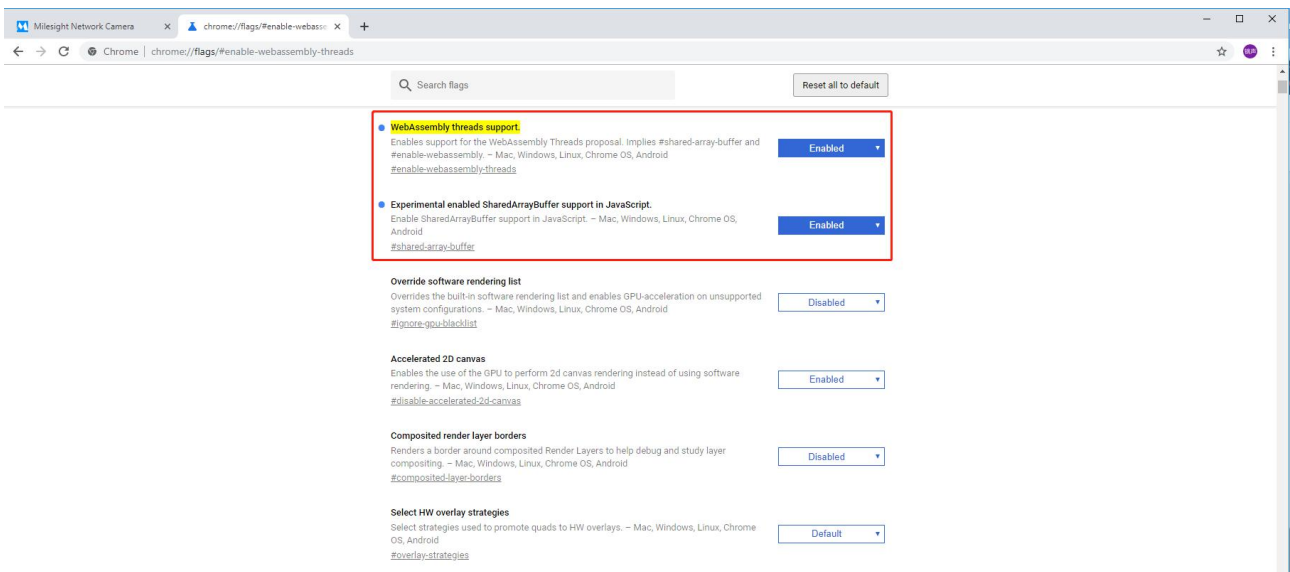

Step5: Then you can preview the video without plugin by selecting Plugin-Free mode in Live View interface.

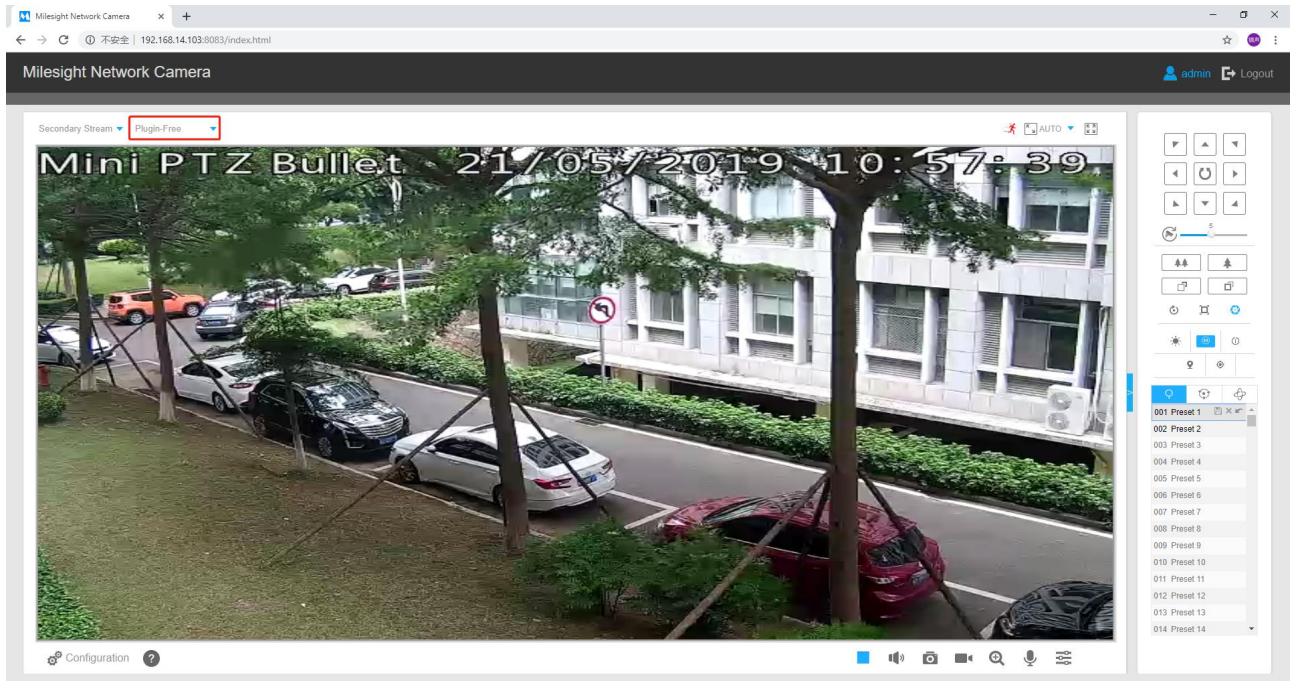

It supports previewing the video in Live View and other setting interfaces.

(2) On Firefox browser

Step1: Access camera via Firefox browser.

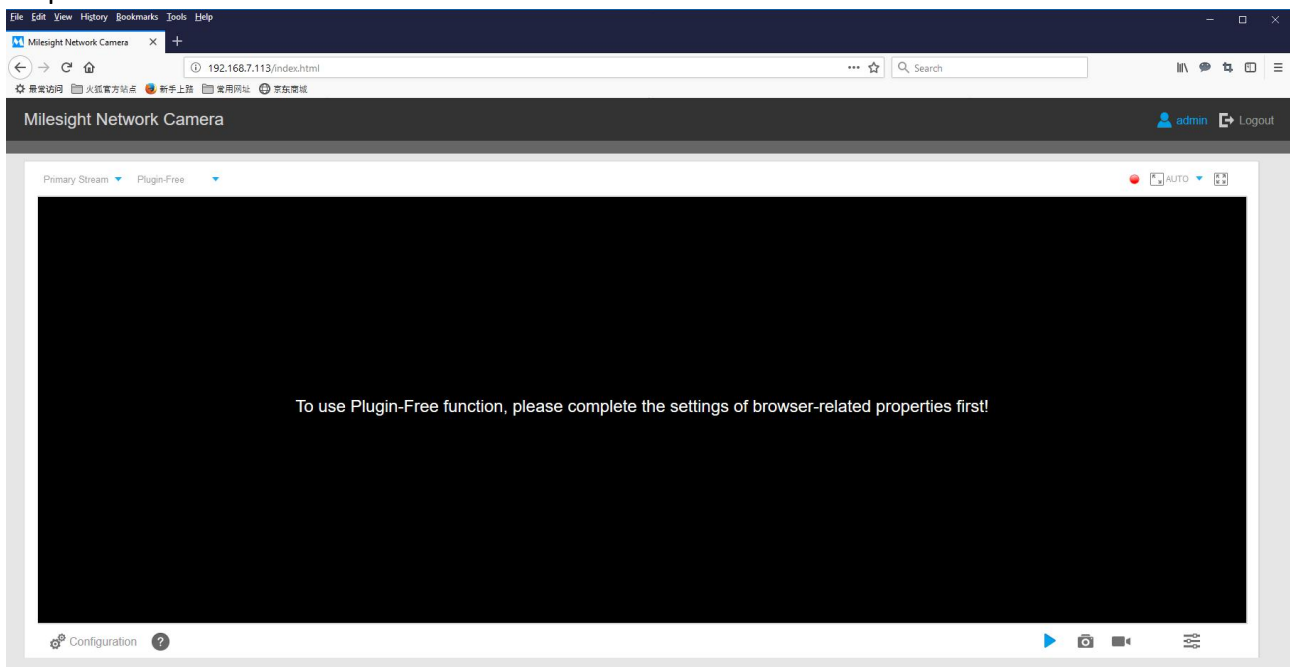

Step2: Click “” icon in the lower left corner of the webpage, you can refer to Plugin-Free Mode instruction below.

Plugin-Free Mode instruction:

Step 1:

Input the URL in address bar:

<about:config>

And accept the requiring.

Step 2:

Set 2 flags to Enabled status and reboot browser:

--javascript.options.wasm.

--javascript.options.shared_memory.

Step3: Input the URL in address bar: <about:config>

And accept the requiring.

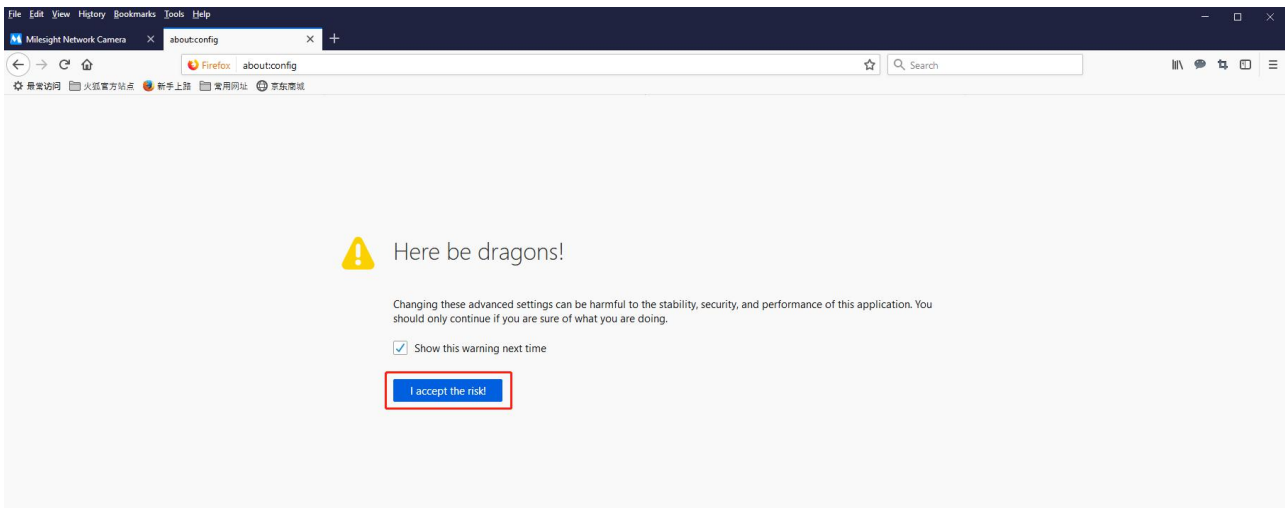

You will enter the webpage shown below.

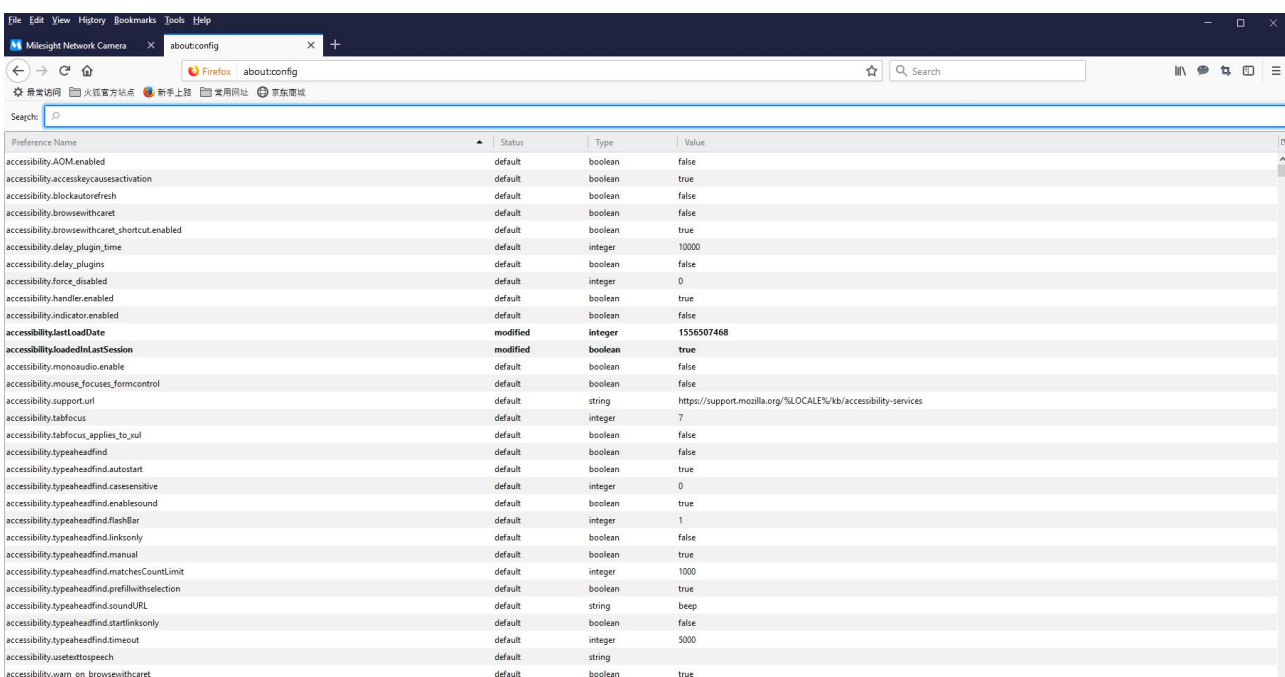

Step4: Set 2 flags to Enabled status and reboot browser:

```
--javascript.options.wasm.  
--javascript.options.shared_memory.
```

Preference Name	Status	Type	Value
javascript.options.wasm	default	boolean	true
javascript.options.wasm_baselinejit	default	boolean	true
javascript.options.wasm_ionjit	default	boolean	true
javascript.options.wasm_verbose	default	boolean	false

Preference Name	Status	Type	Value
javascript.options.shared_memory	modified	boolean	true

Step5: Then you can preview the video without plugin by selecting Plugin-Free mode.

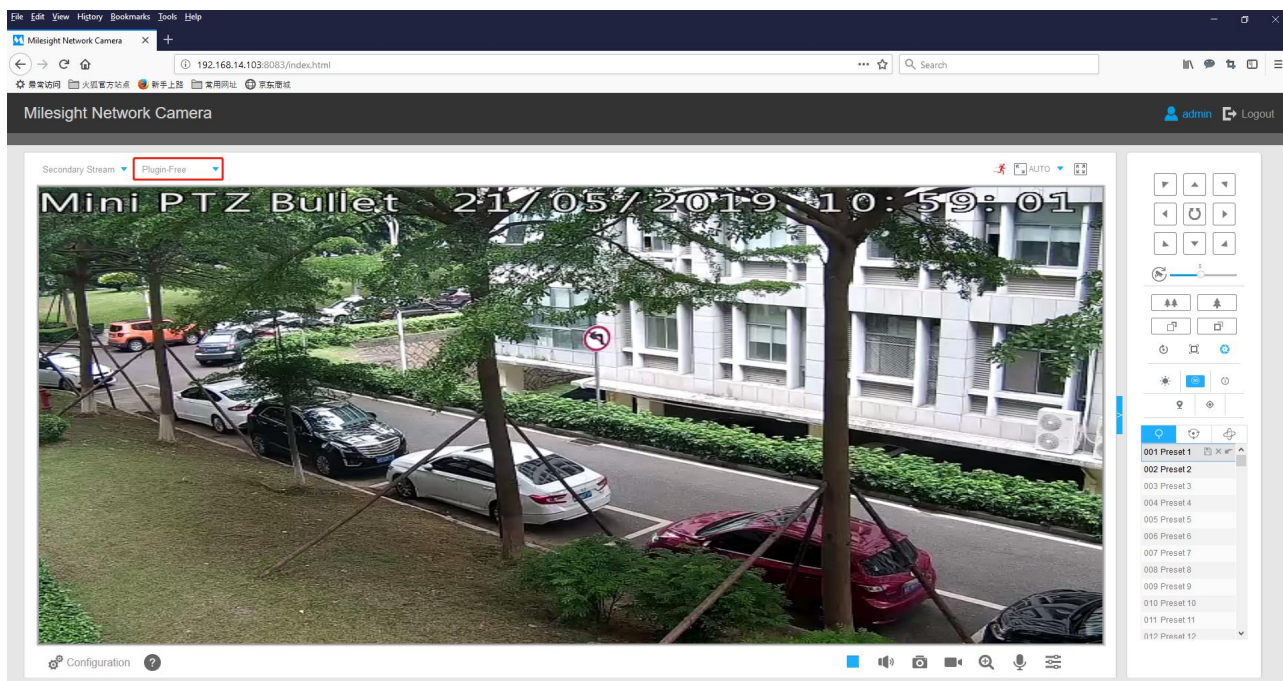

It supports previewing the video in Live View, Playback and other setting interfaces.

3.3 Accessing from Milesight VMS (Video Management Software)

Milesight VMS(ONVIF compatible) is a handy and reliable application designed to work with network cameras in order to provide video surveillance, recording settings and event management functions. The interface of Milesight VMS is very easy to use, intuitive, with easy access to the most common activities, such as viewing live video, searching through recordings and exporting videos and snapshots. It's able to be integrated with other devices through ONVIF. It is designed to work on Windows XP/ 7/ 8/ Vista/ Server 2000/ Server 2008. The software could be downloaded from our website www.milesight.com.

Please install Milesight VMS; then launch the program to add the camera to the channel list. For detailed information about how to use the software, please refer to user manual of Milesight VMS.

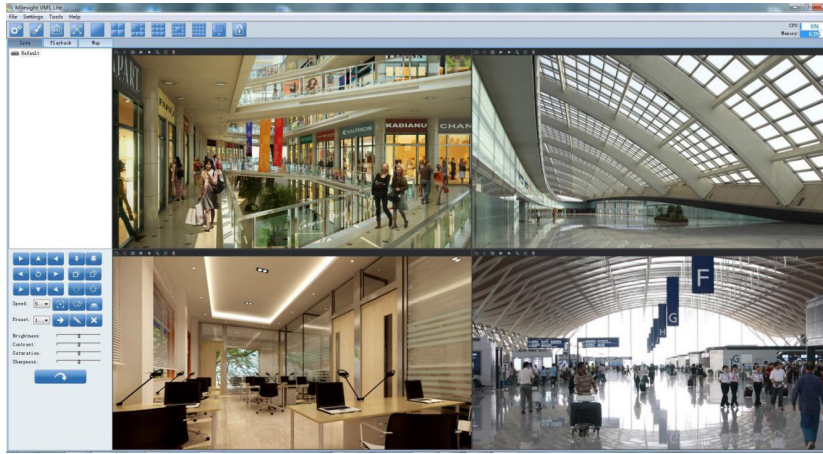

Chapter IV System Operation Guide



4.1 Live Video

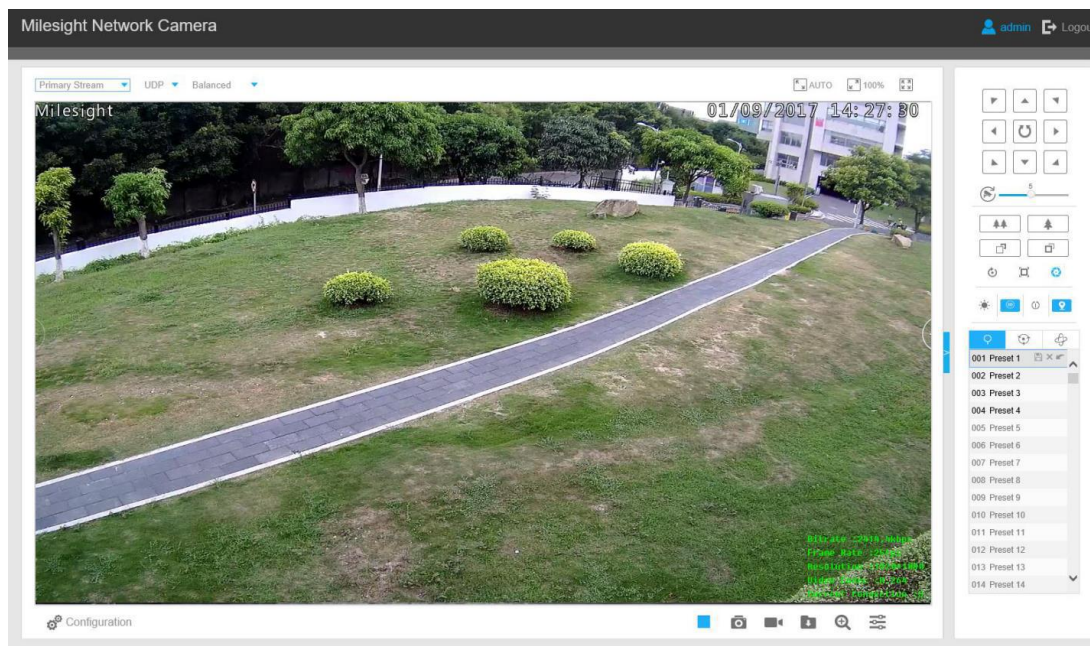









After logging in the network camera web GUI successfully, you are allowed to view live video as follows.

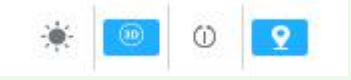

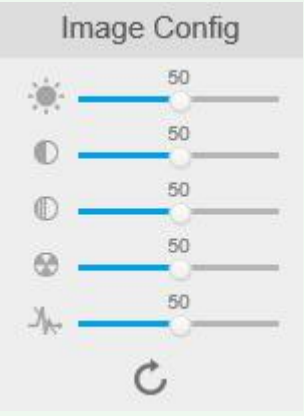









4.1.1 Operations on Live View Page

Table 4-1-1 Description of the buttons

No.	Parameter	Description
1	 <p>PTZ Control</p>	Navigation key is used to control the direction. The rotation key is used for auto-rotation.
	 <p>PTZ Speed</p>	To adjust the speed of pan/tilt movements, from 1 to 10
2		Click to zoom in and zoom out

3		Click to focus near or far of the lens.
4		Lens Initialization, Auxiliary Focus and Auto Iris
5		Lighting For 30s: Click to open/ close the White LED for lighting 30s.
		3D Positioning: Click to enable/ disable 3D positioning.
		One-touch Patrol: Click to carry out the patrol. Auto Home: Click to enable Auto Home.
		Brightness: Drag to adjust brightness of the image.
	Contrast: Drag to adjust color and light contrast.	
	Saturation: Drag to adjust color saturation of the image.	
	Sharpness: Drag to enhance the detail of the image by sharpening the edges in the image.	
	Noise Reduction Level: Drag to adjust the noise reduction level.	
Default: Drag to restore brightness, contrast and saturation to default setup.		
8		Configuration: Click to access the configuration page.
9		To choose the Stream (Primary/Secondary/Tertiary) to be shown on the current video window.
10		Web Components: Support Firefox, Safari, Chrome; need to install the component to display the view;
		MJPEG: Support to display the view on Firefox, Safari, Chrome; (NOTE: IE chooses Web Components mode as default. In this case, the options will not appear.)
11		TCP: More reliable connection; UDP: More instantaneous connection, but if you cannot get the live view successfully, please turn into TCP connection. HTTP: Faster and safer connection especially in Internet environment.
12		Least Delay: The most instantaneous mode in the three modes; Balanced: A balanced mode between Least Delay and Best Fluency, maintains the fluency while keeps an acceptable delay; Best Fluency: The most fluent mode in the three modes.

13	 Window size	Click to display images at a window size.
14	 Real size	Click to display images at a real size.
15	 Full Screen	Click to display images at full-screen.
16	 Recording	When recording, the icon will turn red.
17	 Alarm	When an alarm of Smart Event was triggered, the icon appears
18	 Alarm	When an alarm of Motion Detection was triggered, the icon appears
19	 Alarm	Except for the two kinds of alarms above, when other alarms were triggered, the icon appears
20	 /	Click to start/stop Live View.
21	 Capture	Click to capture the current image and save to the configured path. The default path is C:\VMS\+-1\ IMAGE-MANUAL.
22	 / Start/Stop Recording	Click to start recording video and save to the configured path. The default path is C:\VMS\+-1\MS_Record. Click again to stop recording.
23	 Play Audio	Click to enable Audio Input/Output. It can also be set in Audio configuration page.
24	 Saving Path Settings	Click to set the saving path for captured images and video recordings of operating on the live view.
25	 Enable Digital Zoom	When it is enabled, you can zoom in within a specific area of video image via your mouse wheel.
26	 Start Talking	When it is enabled, you can start real-time talking.

4.1.2 3D Positioning

3D Positioning allows user to use mouse clicking and dragging to control the PTZ.

Steps:

1. Click  on the toolbar of Live View interface.
2. Operate the 3D positioning function
 - Left click a position of the Live View, the corresponding position will be moved to the center of the Live View.
 - Hold down the left mouse button and drag the mouse to the lower right or upper right on the Live View, you can see a blue rectangle. The corresponding position will be moved to the center of the Live View and Zoom in.
 - Hold down the left mouse button and drag the mouse to the lower left or upper left on the Live View, you can see a blue rectangle. The corresponding position will be moved to the center of the Live View and Zoom out.
 - The Bigger the rectangle is, the smaller zoom in/out will be acted.

4.1.3 Set / Call a preset / Patrol / Pattern

A preset is a predefined image position. You can click the call button from the preset list to quickly go to the desired image position.

Set a preset:

Step1: In the PTZ control panel, select a preset number from the preset list;

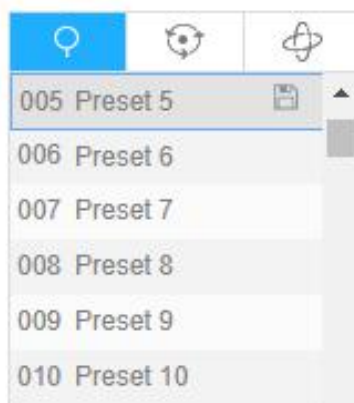

Step2: Use the PTZ control buttons to move the lens to the interested position;

Step3: Click  to save the setting of the current preset;

Step4: Click  to delete the chosen preset.

Note:

Up to 237 presets can be configured (18 presets are not modifiable).

Calling a preset:

Select a defined preset from the preset list and click  to call the preset.

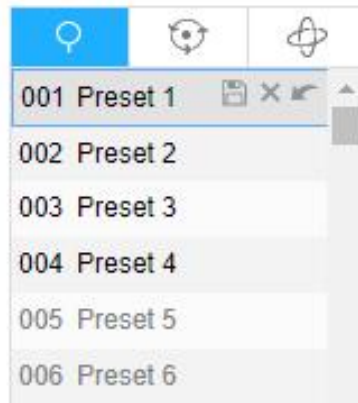

Note:

The following presets are predefined with special commands. You can only call them but can't configure them. For example, preset 037 is the "Self Check". If you call the preset number 037, the PTZ camera will start self check function at once.

Table 4-1-2 Special Presets

Special Preset	Function	Special Preset	Function
33	Auto Flip(Speed Dome only)	42	Path6
34	Goto Zero	43	Path7
35	Self Check	44	Path8
36	Patrol	45	Pattern1
37	Path1	46	Pattern2
38	Path2	47	Pattern3
39	Path3	48	Pattern4
40	Path4	49	Stop Scan
41	Path5	50	Auto Scan



Set / Call a patrol

A patrol is a memorized series of preset function. It can be configured and called on the patrol setting list. You can customize up to 8 patrols and it can be configured with 48 presets. Before configuring the patrol, you should make sure that the presets you want to add to the patrol have been defined.

Set a patrol:

Step1: In the PTZ control panel, click  to enter the patrol settings interface;

Step2: Select a patrol number, the setting icon will appear , click it;

Step3: Click  to add presets to this patrol, as shown in Figure 4-1-5;

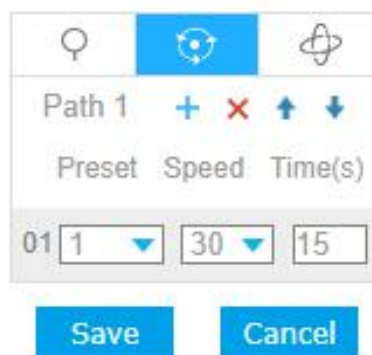

Step4: Configure the preset number, patrol speed and patrol time;

Table 4-1-3 Description of Patrol Settings

Name	Description
Patrol Speed	The speed of moving from one preset to another.
Patrol Time	The duration staying on one patrol point. The PTZ camera moves to another patrol point after the set patrol time.

Step5: Click  to save the patrol settings.

Note:

A. Patrol Speed only works in Patrol mode.

B. Patrol Time should be 15~120s for Mini PTZ Bullet and 0~120s for Speed Dome.

Call a patrol:

In the PTZ control panel, select a defined patrol from the patrol list, and click  to call the patrol, as shown below.

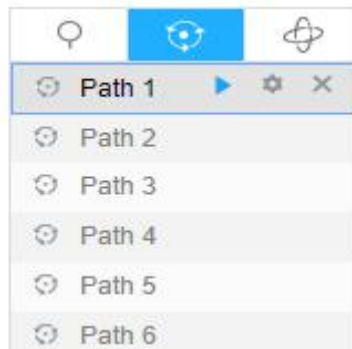
**Note:**

The three buttons behind the Patrol list means: Play, Set and Delete.

Set / Call a pattern

A pattern is a memorized series of pan, tilt, zoom and preset functions. It can be called on the pattern settings interface. There are up to 4 patterns can be set.

Set a pattern:

Step1: In the PTZ control panel, click  to enter the pattern settings interface;

Step2: Select a pattern number from the pattern list as shown in the figure below;

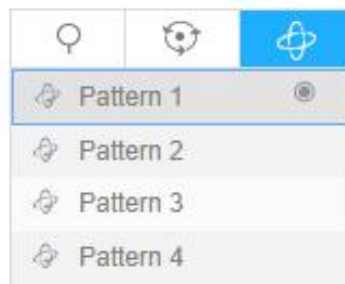

Step3: Click  to activate recording the panning, tilting and zooming actions;

Step4: Use the PTZ controller buttons to move the lens to the interested position;

Step5: Click  to save all the pattern settings.

Note:

The percentage of number on the OSD is the remaining space of pattern. Start with 100% and run out of 0%.

Call a pattern:

In the PTZ control panel, select a defined pattern from the pattern list, click  to call the pattern, as shown in the figure below.

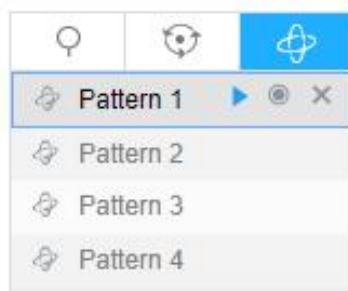
**Note:**

The three button behind the Pattern list means: Play, Record and Delete.

When configuring the pattern, pan and tilt are valid but the limit stops and auto flip will be invalid.
Also, 3D Positioning operation is not supported.

4.2 Playback

This section explains how to view the recorded video files stored in SD cards or NAS.

Step1: Click  Configuration and then click  Playback on the menu bar to enter playback interface;

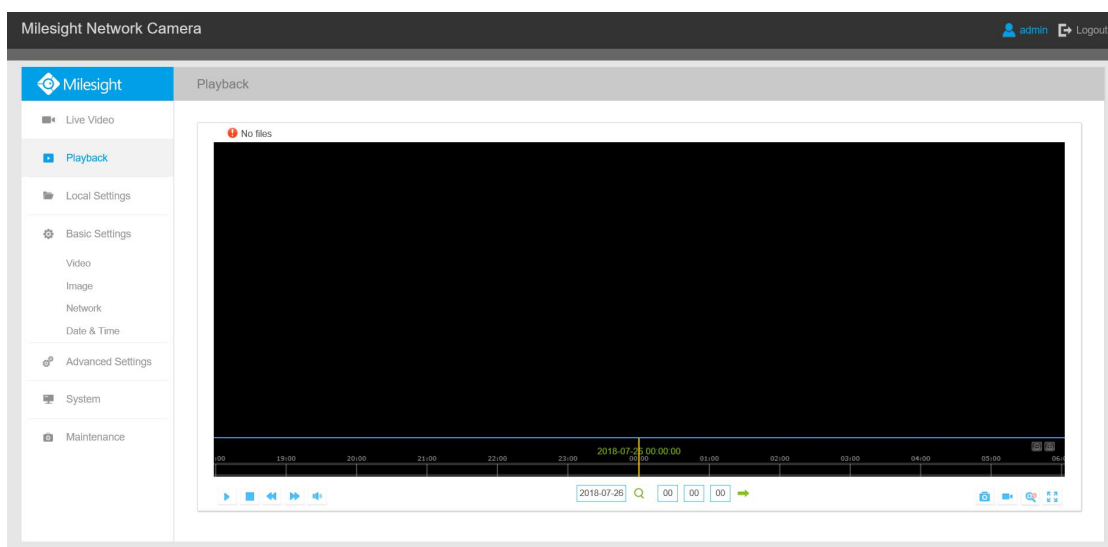

Step2: Click the date button, choose the date when date window pops up;

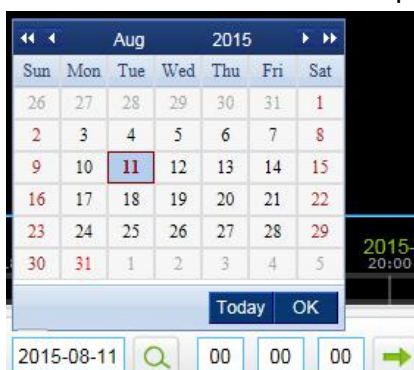
**Note:**

- 1) The date with bright red means current date; one with a dark red number and white background means weekend day; one with a dark red number and blue background means that the date is selected now.
- 2) It supports Plugin-free Playback function which allows to preview the playback without installing plugin in Firefox (Version 65 and above) & Google Chrome (Version 69 and above) ; You need to configure the browser properties before using this function. Please refer to **3.2.2 Access without Plugin** for more browser configuration.

Step3: Click  to play the video files found on this date.

The toolbar on the button of playback interface can be used to control playing progress.

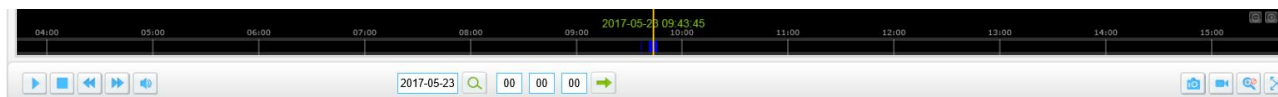



Table 4-2-1 Description of the buttons

Button	Operation
	Play
	Pause
	Stop
	Speed Down
	Speed Up
	Audio On/Off
	Search
	Go To
	Time Narrow/Expand
	Start/Stop Recording
	Snapshot
	Zoom On/Off
	Full Screen

Note:

Drag the progress bar with the mouse to locate the exact playback point. You can also input the time and click  to locate the playback point in the *Set Playback Time* filed. You can also click

/ to zoom out/in the progress bar.



4.3 Local Settings

Record File Length and storage path can be customized in this setting page.

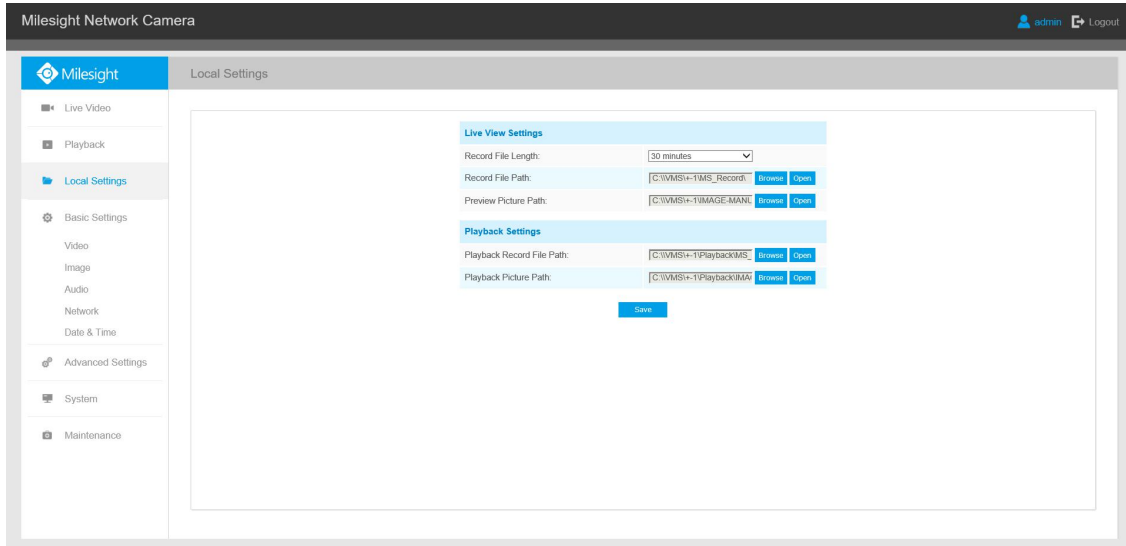

4.4 Basic Settings

4.4.1 Video

Stream parameters can be set in this module, adapting to different network environments and demands.

Primary Stream Settings

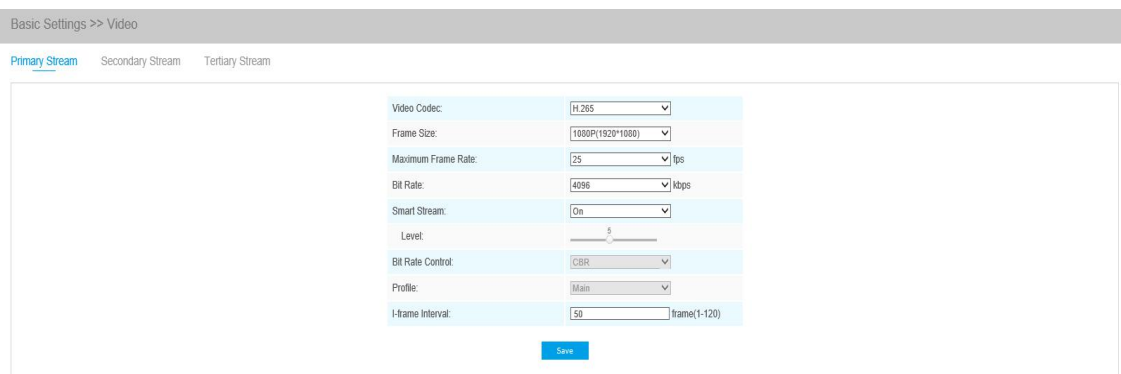

Secondary Stream Settings

Basic Settings >> Video

Primary Stream **Secondary Stream** Tertiary Stream

Enable:	<input checked="" type="checkbox"/>
Video Codec:	H.265
Frame Size:	640*480
Maximum Frame Rate:	25 fps
Bit Rate:	512 kbps
Smart Stream:	On
Level:	5
Bit Rate Control:	CBR
Profile:	Main
I-frame Interval:	50 frame(1-120)

Tertiary Stream Settings

Basic Settings >> Video

Primary Stream Secondary Stream **Tertiary Stream**

Enable:	<input checked="" type="checkbox"/>
Video Codec:	H.264
Frame Size:	640*480
Maximum Frame Rate:	25 fps
Bit Rate:	1024 kbps
Smart Stream:	On
Level:	5
Bit Rate Control:	CBR
Profile:	Main
I-frame Interval:	50 frame(1-120)

Table 4-4-1 Description of the buttons

Parameters	Function Introduction
Video Codec	H.265/H.264/MJPEG are available.
Frame Size	Options include 5M(2592*1944)(only for 5MP Mini PTZ Bullet and 5MP Speed Dome), 4M(2592*1520)(only for 5MP Mini PTZ Bullet and 5MP Speed Dome), 3M(2304*1296), 1080P(1920*1080), 1.3M(1280*960), 720P(1280*720), D1 (704*576). For Secondary Stream, it includes 704*576, 640*480, 640*360, 352*288, 320*240, 320*192, 320*176. For Tertiary Stream, it include 1920*1080, 1280*720, 704*576, 640*480, 640*360, 352*288, 320*240, 320*192, 320*176.
Maximum Frame Rate	It means maximum refresh frame rate of per second.
Bit Rate	Set the bitrate to 32~16384 Kbps. The higher value corresponds to the higher video quality, and the higher bandwidth is required as well.
Smart Stream	Smart Stream mode remarkably reduces the bandwidth and the data storage requirements for network cameras while ensuring the high quality of images, and it is a 10-level adjustable codec. It is optional to turn On/Off Smart Stream mode. Level: Level 1~10 are available to meet your need.

Bit Rate Control	CBR: Constant Bitrate. The rate of CBR output is constant.
	VBR: Variable Bitrate. VBR files vary the amount of output data per time segment.
Image Quality	Low/Medium/High are available, this item is optional only if you select VBR.
Profile	The option is for H.264. Main/High/Base can be selected according to your needs.
I-frame Interval	Set the I-frame interval to 1~120, 50 for the default. The number must be a multiple of the number of frames
JPEG Quality	Low/Medium/High/Higher are available, this item is optional only if you select the MJPEG

Note:

The options of [Frame Size] are variable according to the model selected.

4.4.2 Image

Display information, enhancement of image and Day/Night setting can be set in this module. OSD (On Screen Display) content and video time can be displayed to rich the image information.

Display

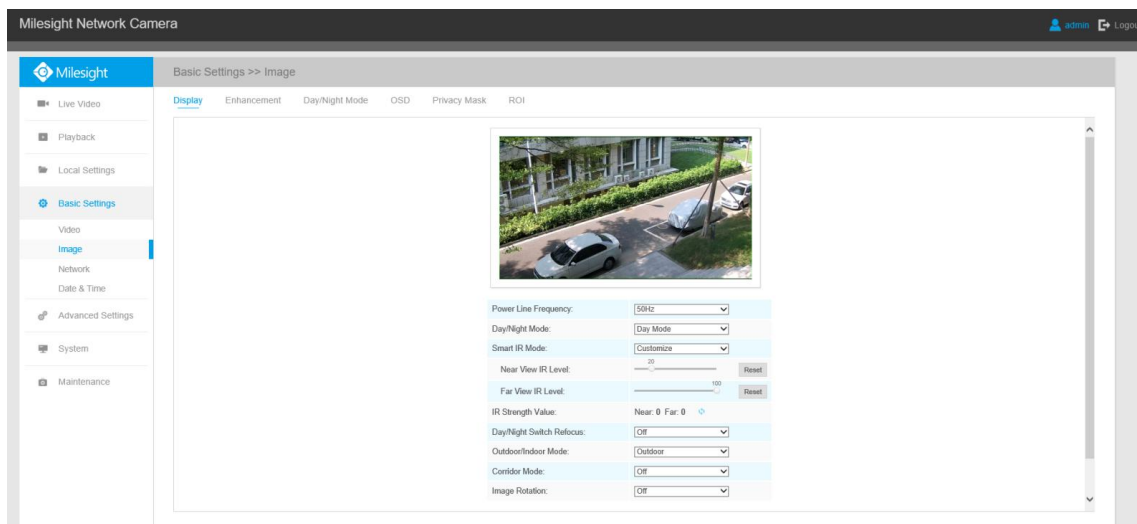

Table 4-4-2 Description of the buttons

Parameters	Function Introduction
Power Line Frequency	60HZ flicker for NTSC mode and 50HZ flicker for PAL mode

Day/Night Mode	<p>There are several parameters such as Exposure Level, Maximum Exposure Time and IR-CUT Interval, etc, associated with this mode.</p> <p>Night Mode: Show in live view based on Night Mode settings</p> <p>Day Mode: Show in live view based on Day Mode settings</p> <p>Auto Mode: Show in live view based on environment, set the sensitivity for switching Day Mode to Night Mode, or Night Mode to Day Mode</p> <p>Customize: Show in live view based on your own settings' time to start/end Night Mode</p>
Day To Night Value	<p>This is the sensitivity for switching Day Mode to Night Mode. When IR Light Sensor Current Value is lower than this value, it will switch Day Mode to Night Mode.</p>
Night To Day Value	<p>This is the sensitivity for switching Night Mode to Day Mode. When IR Light Sensor Current Value is higher than this value, it will switch Night Mode to Day Mode.</p>
IR Light Sensor Value	<p>The current value of the IR light sensor</p>
Smart IR Mode	<p>With the combination of the High Beam and Low Beam, The IR LEDs technology has been upgraded to provide better image clarity and quality regardless of the object distance. Also, the Low Beam and High Beam's brightness can be adjusted manually or automatically on the basis of the Zoom ratio. Moreover, with the IR anti-reflection panel, the infrared light transmittance is highly increased.</p> <p>Support to set the strength of the IR to Auto Mode or Customize to achieve the best effect.</p> <p>Speed Dome has 8 LED lights, 4 are High Beams and 4 are Low Beams. And Mini PTZ Bullet has 4 LED lights, 2 are High Beams and 2 are Low Beams.</p>
Near view level	<p>Adjust the light strength of Low-Beams LED light level from 0 to 100.</p>
Far view level	<p>Adjust the light strength of High-Beams LED light level from 0 to 100.</p>
IR Strength Value	<p>The current value of Low-Beams LED and High-Beams LED light value</p>
Day/Night Switch Refocus	<p>With this option enabled, the camera will refocus when switching between day mode and night mode.</p>
Outdoor/Indoor Mode	<p>Select indoor or outdoor mode to meet your needs.</p>
Corridor Mode	<p>There are three options available, you can select one to meet your need</p> <p>Off: Keep the image in normal direction</p> <p>Clockwise 90°: Rotate the image by 90° clockwise</p> <p>Anticlockwise 90°: Rotate the image by 90° anticlockwise</p>

<p>Image Rotation</p>	<p>There are four options available, you can select one to meet your need</p> <p>Off: Keep the image in normal direction</p> <p>Rotating 180°: Upside down the image</p> <p>Flip Horizontal: Flip the image horizontally</p> <p>Flip vertical: Flip the image vertically</p>
<p>Smoked Dome Cover</p>	<p>This function is only for Mini PTZ Dome. If Mini PTZ Dome is equipped with a Smoked Dome Cover, enable this function to display a normal image.</p>

Enhancement

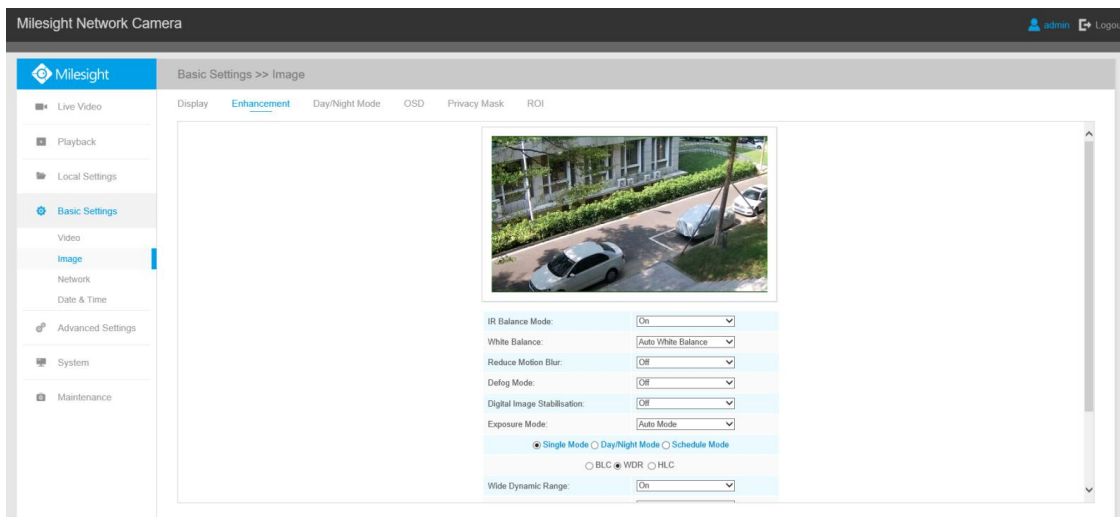

Table 4-4-3 Description of the buttons

Parameters	Function Introduction
<p>IR Balance Mode</p>	<p>There is an option to turn On/Off the IR LED.</p> <p>IR Balance Mode would avoid the problem of overexposure or darkness, and the IR LED will change according to the actual illumination.</p>
<p>White Balance</p>	<p>To restore white objects and remove color distortion cause by the light of the environment</p> <p>Auto White Balance: This option will automatically enable the White Balance function;</p> <p>Manual White Balance: Set Red Gain Level and Blue Gain Level manually;</p> <p>Incandescent Lamp: Select this option when light is similar with incandescent lamp;</p> <p>Warm Light Lamp: Select this option when light is similar with warm light lamp;</p> <p>Natural Light: Select this option when there is no other light but natural light;</p> <p>Fluorescent Lamp: Select this option when light is similar with Fluorescent Lamp.</p> <p>Schedule mode: Select this option that you can customize the schedule to enable/disable above modes</p>
<p>Reduce Motion Blur</p>	<p>Enable this function to reduce the motion blur of objects effectively.</p>

	You can adjust the deblur level from 1 to 100.
Defog Mode	Better image effect in foggy weather, refers to Figure 4-4-9
Digital Image Stabilisation	Decrease the blur and shakiness of the image.
Exposure Mode	<p>Auto Mode, Manual Mode and Schedule Mode are available.</p> <p>Auto Mode: The camera will adjust the brightness according to the light environment automatically;</p> <p>Manual Mode: The camera will adjust the brightness according to the value you set, you can set the exposure time from 1~1/100000s, the higher the value is, the brighter the image is;</p> <p>Schedule Mode: You can customize the schedule to enable/disable Auto Mode and Manual Mode.</p>
Single Mode	Set single mode for BLC/WDR/HLC.
Day/Night Mode	Support BLC/WDR/HLC on Day Enhancement Mode/Night Enhancement Mode separately.
Schedule Mode	Set schedule mode for BLC/WDR/HLC.
BLC Region	<p>Off, Customize, and Centre are available (in single mode, only enable when WDR is disable)</p> <p>Off: Calculate the full range of view and offer appropriate light compensation</p> <p>Customize: This option enables you to customize inclusive or exclusive region manually</p> <p>Centre: This option will automatically add an inclusive region in the middle of the window and give the necessary light compensation</p>
Wide Dynamic Range	<p>This function which can capture and display both bright and dark areas in the same frame enables details of objects in both bright and dark areas to be visible.</p> <p>Off: Disable WDR function</p> <p>On: Enable the WDR, there are Low/High/Auto three levels</p> <p>Customize: Customize the schedule to enable/disable the WDR function and set the levels with Low/High/Auto</p>
Wide Dynamic Level	Set WDR with Low/High/Auto level
Anti-flicker Level	Reduce flickers that appear on screen in some lighting conditions and there are 10 levels of anti-flicker adjustments
High Light Compensation	<p>This function is only for H.265 series to adjust the brightness to a normal range when the light is strong, refers to Figure 4-4-10</p> <p>Off: Disable HLC function</p> <p>General Mode: Enable the general mode of HLC, and there is a setting for HLC Level</p> <p>Enhanced Mode: Enable the enhanced mode of HLC, and there is a setting for HLC Level</p>

HLC Level	Select level for HLC
Day Enhancement Mode	BLC/WDR/HLC are available.
Night Enhancement Mode	BLC/WDR/HLC are available.
Schedule Setting	Customize the schedule to enable/disable BLC/WDR/HLC mode

Note:

1) You can customize the schedule to enable/disable the difference White Balance modes.

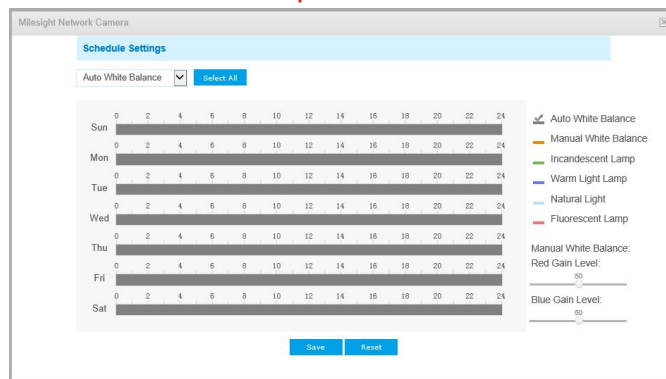

2) You can customize the schedule to enable/disable the difference exposure modes.

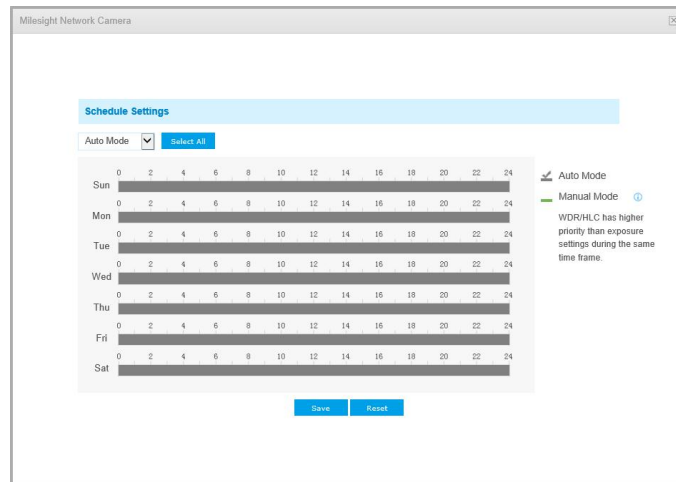

3) You can customize the schedule to enable/disable BLC/WDR/HLC mode.

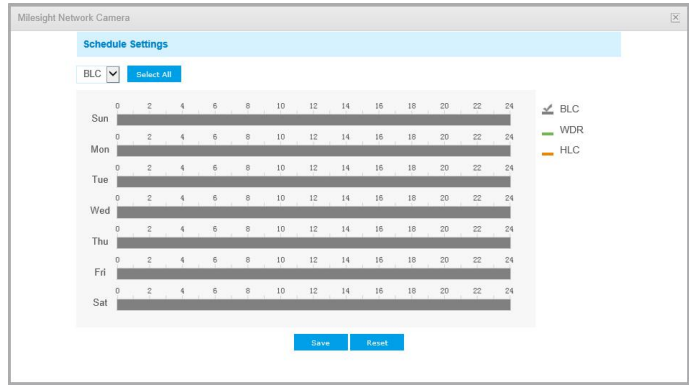

- 4) WDR/HLC has higher priority than exposure settings at the same time frame.
- 5) Defog Image.



- 6) HLC Image.



Day/Night Mode

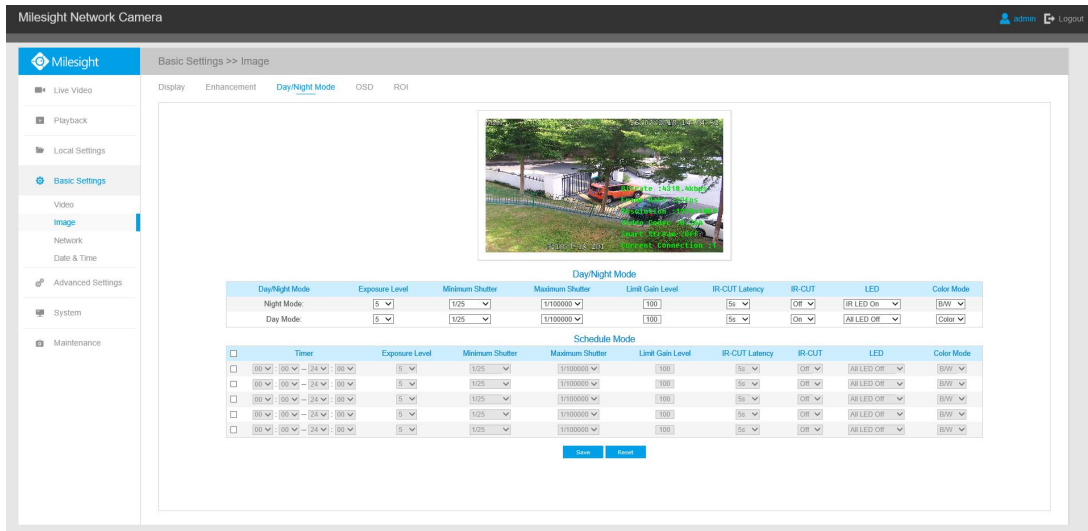

Table 4-4-4 Description of the buttons

Parameters	Function Introduction
Exposure Level	Level 0~10 are available to meet your need.
Minimum Shutter	Minimum Shutter is the same as Maximum Exposure Time. Set the minimum Shutter to 1~1/100000s
Maximum Shutter	Maximum Shutter is the same as Minimum Exposure Time. Set the maximum Shutter to 1~1/100000s
IR-CUT Latency	The interval time of switching one mode to another.
IR-CUT	Turn on or turn off IR-CUT.
LED	Choose to turn on or turn off under this mode. LED off: Turn off all the LEDs on the device; IR LED on: Turn on the IR LED; White LED on: Turn on the White LED (Only for Mini PTZ Bullet).
Color Mode	Select B/W or Color mode under Day/Night mode.
Schedule Mode	By this you can customize your special demands for different time, then the Day mode and Night mode will switch automatically according to your settings.

OSD(On Screen Display)

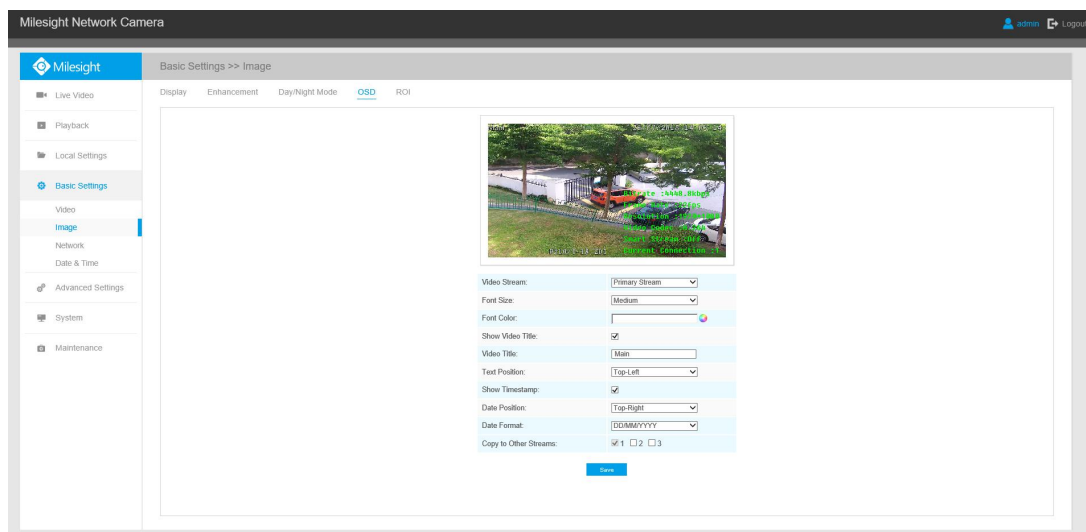

Table 4-4-5 Description of the buttons

Parameters	Function Introduction
Video Stream	Enable to set OSD for primary stream and secondary stream
Font Size	Smallest/Small/Medium/Large/Largest/Auto are available for title and date
Font Color	Enable to set different color for title and date
Show Video Title	Check the checkbox to show video title
Video Title	Customize the OSD content
Text Position	OSD display position on the image
Show Timestamp	Check the checkbox to display date on the image
Date Position	Date display position on the image
Date Format	The format of date
Copy to Other Streams	Copy the settings to other streams

ROI

Region of interest(often abbreviate ROI), is a selected subset of samples within a dataset identified for a particular purpose. Users can select up to 8 key regions of a scene to transmit through separate streams for targeted preview and recording.

By using Milesight ROI technology, more than 50% of bit rate can be saved and therefore less bandwidth demanded and the storage usage reduced. So according to this, you can set a small bit

rate for high resolution.

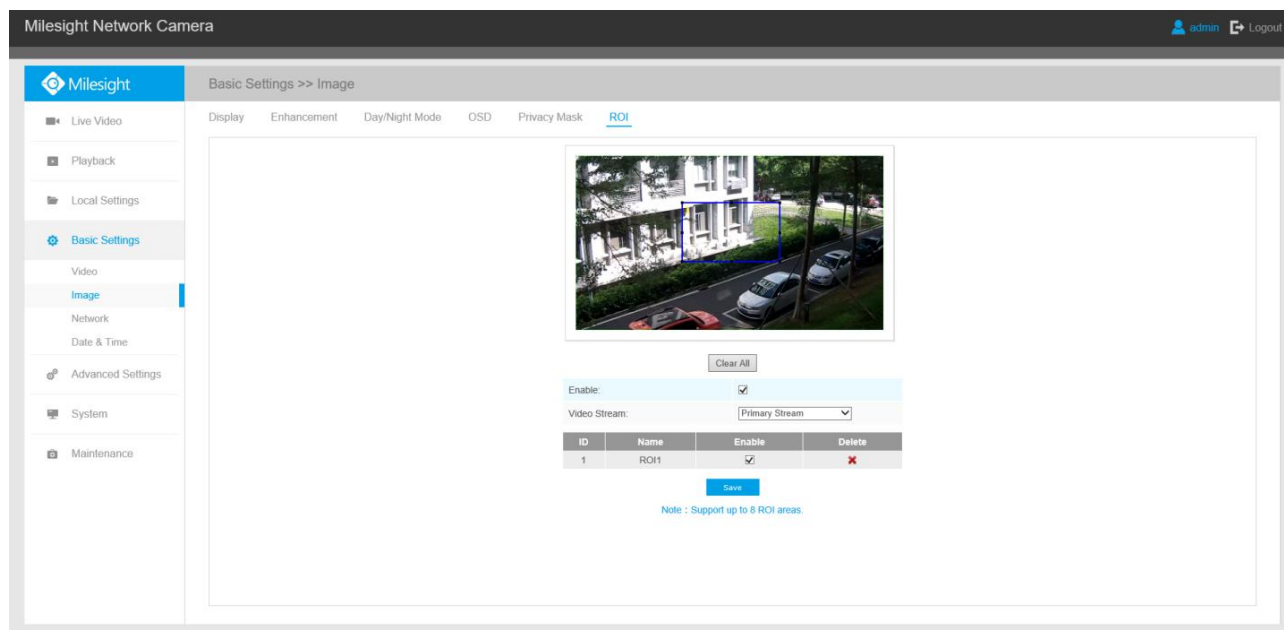

Table 4-4-6 Description of the buttons

Parameters	Function Introduction
Enable	Check the checkbox to enable the ROI function
Clear All	Clear all areas you drew before
Video Stream	Choose the Video Stream

Note:

You can set a low bit rate. For example, you can set a bit rate of 512Kbps and a resolution of 1080P, then you can see the image quality of ROI is more clear and fluent than the other region.

4.4.3 Audio

This audio function allows you to hear the sound from the camera or transmit your sound to the camera side. A two-way communication is also possible to be achieved with this feature. Alarm can be triggered when the audio input is above a certain alarm level you set, and configured audio can be played when an alarm occurs.

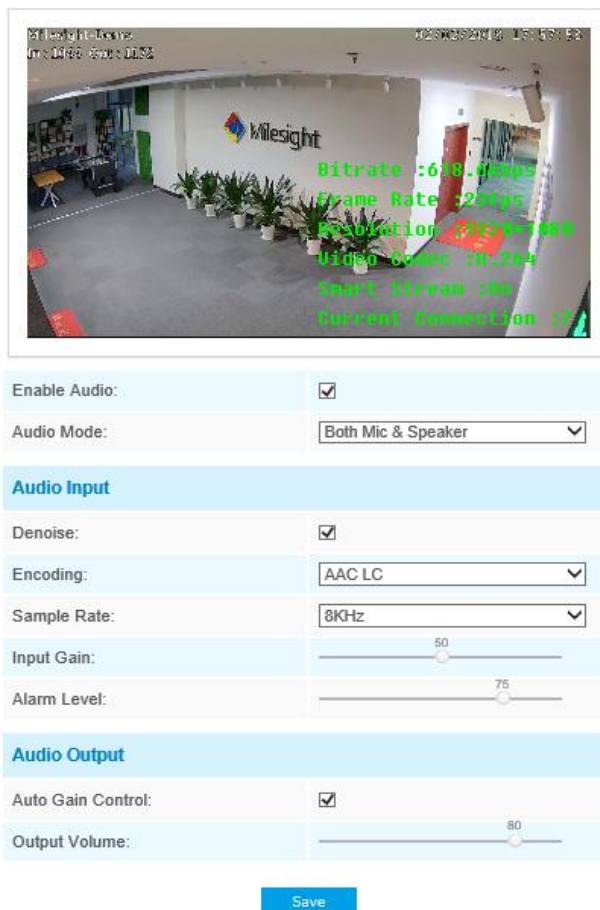

Table 4-4-7 Description of the buttons

Parameters	Function Introduction
Enable Audio	Check on the checkbox to enable audio feature.
Audio Input	<p>Denoise: Set it as On/Off. When you set the function on, the noise detected can be filtered.</p> <p>Encoding: G711-ULaw, G711-ALaw and AAC LC are available;</p> <p>Sample Rate: There are 8KHz/16KHz two options;</p> <p>Input Gain: Input audio gain level, 0-100;</p> <p>Alarm Level: Alarm will be triggered if voice alarm is enabled and input gained volume is higher than the alarm level, 0-100.</p>
Audio Output	<p>Auto Gain Control: Improve the quality of audio;</p> <p>Output Volume: Adjust volume of output.</p>

You can upload up to 5 audio files manually to Flash or SD Card on the Audio web page and you can also edit the audio file's name when upload.

Audio File Storage Type:

Audio File Upload

Audio File Name:

Audio File:

ID	Audio File Name	Delete
1	audio	<input type="button" value="✘"/>

Note: Only support '.wav' audio files with codec type PCM/PCMU/PCMA, 64kbps or 128kbps bitrate and no more than 500k!

Note:

Only support '.wav' audio files with codec type PCM/PCMU/PCMA, 64kbps or 128 kbps and no more than 500k.

4.4.4 Network

TCP/IP

Get IPv4 address automatically

Use fixed IPv4 address

IP Address:

IPv4 Subnet Mask:

IPv4 Default Gateway:

Preferred DNS Server:

IPv6 Mode:

IPv6 Address:

IPv6 Prefix:

IPv6 Default Gateway:

Table 4-4-8 Description of the buttons

Parameters	Function Introduction
Get IPv4 Address Automatically	Get an IP address from the DHCP server automatically.
Use fixed IP address	<p>IPv4 Address: It is used to identify a network camera on the network;</p> <p>IPv4 Subnet Mask: It is used for identifying the subnet where the network camera is located;</p> <p>IPv4 Default Gateway: It is the default router address;</p> <p>Preferred DNS Server: The DNS Server translates the domain name to IP address;</p> <p>IPv6 Mode: Choose different mode for IPv6: Manual/Route Advertisement/DHCPv6;</p>

<p>IPv6 Address: It is used to identify a network camera on the network;</p> <p>IPv6 Prefix: Define the prefix length of IPv6 address;</p> <p>IPv6 Default Gateway: The default router IPv6 address.</p>

Note:
The **Test** button is used to test if the IP is conflicting.

HTTP

Table 4-4-9 Description of the buttons

Parameters	Function Introduction
HTTP Enable	Start or stop using HTTP.
HTTP Port	Web GUI login port, the default is 80, the same with ONVIF port.
HTTPS Enable	Start or stop using HTTPS.
HTTPS Port	Web GUI login port via HTTPS. the default is 443.
HTTP Settings	Upload and set the SSL certificate .

HTTP URL are as below:

Stream	URL
Main Stream	http://username:password@IP:port/ipcam/mjpeg.cgi

Secondary Stream	http://username:password@IP:port/ipcam/mjpegcif.cgi
Tertiary Stream	http://username:password@IP:port/mjpegthird.cgi

RTSP

RTSP Port:	<input type="text" value="554"/>	
Playback Port:	<input type="text" value="555"/>	
RTP Packet:	<input type="text" value="Better Compatibility"/>	
Multicast Group Address:	<input type="text" value="239 . 6 . 6 . 6"/>	
QoS DSCP(0~63):	<input type="text" value="0"/>	

Table 4-4-10 Description of the buttons

Parameters	Function Introduction
RTSP Port	The port of RTSP, the default is 554.
Playback Port	The port of playback, the default is 555.
RTP Packet	There are Better Compatibility and Better Performance two options. If your camera's image mess up, please switch this option.
Multicast Group Address	Support multicast function.
QoS DSCP	The valid value range of the DSCP is 0-63.

RTSP URL are as below:

Stream	URL
Main Stream	rtsp://username:password@IP:port/main
Secondary Stream	rtsp://username:password@IP:port/sub
Tertiary Stream	http://username:password@IP:port/third

Note:

- 1) Get the format of RTSP URL by clicking " " on the right side of RTSP Port.
- 2) Get the playback tip by clicking " " on the right side of Playback Port.
- 3) DSCP refers to the Differentiated Service Code Point; and the DSCP value is used in the IP header to indicate the priority of the data.

- 4) A reboot is required for the settings to take effect.
- 5) The tertiary stream is only equipped on camera whose model with “-A” or “-B”.

UPnP

Universal Plug and Play (UPnP) is a networking architecture that provides compatibility among networking equipment, software and other hardware devices. The UPnP protocol allows devices to connect seamlessly and to simplify the implementation of networks in the home and corporate environments. With the function enabled, you don’t need to configure the port mapping for each port, and the camera is connected to the Wide Area Network via the router.

Enable UPnP:

Port Mapping

Enable Port Mapping:

Name:

Type:

Protocol Name	External Port	Internal Port	Status
HTTP	<input type="text" value="21202"/>	<input type="text" value="80"/>	Invalid
RTSP	<input type="text" value="23202"/>	<input type="text" value="554"/>	Invalid
Playback	<input type="text" value="25202"/>	<input type="text" value="555"/>	Invalid

Table 4-4-11 Description of the buttons

Parameters	Function Introduction
Enable	Check the checkbox to enable the UPnP function
Enable Port Mapping	Check the checkbox to enable the Port Mapping
Name	The name of the device detected online can be edited
Type	<p>Auto: Automatically obtain the corresponding HTTP and RTSP port, without any settings</p> <p>Manual: Need to manually set the appropriate HTTP port and RTSP Port. When choose Manual, you can customize the value of the port number by yourself</p>

DDNS

DDNS allows you to access the camera via domain names instead of IP address. It manages to change IP address and update your domain information dynamically. You need to register an account from a provider.

DDNS is not running

Enable DDNS:	<input type="checkbox"/>
Provider:	ddns.milesight.com ▼
External HTTP Port:	80
External RTSP Port:	554
External Playback Port:	555
DDNS URL: http://ddns.milesight.com/210C1E	

Note: Recommend to enable and configure UPnP ports which can be used directly in DDNS.

You can choose “ddns.milesight.com” as provider for DDNS. After enabling, you can access the device via the URL “http://ddns.milesight.com/MAC address” .

Table 4-4-12 Description of the buttons

Parameters	Function Introduction
Enable DDNS	Check the checkbox to enable DDNS service
Provider	Get support from DDNS provider: ddns.milesight.com, freedns.afraid.org, dyndns.org, www.no-ip.com, www.zoneedit.com. You can also customize the provider for DDNS.
Hash	A string used for verifying, only for "freedns.afraid.org"
User name	Account name from the DDNS provider, unavailable for "freedns.afraid.org"
Password	Account password, unavailable for "freedns.afraid.org"
Host name	DDNS name enabled in the account

Note:

- 1) Please do the Port Forwarding of HTTP Port and RTSP Port before you use Milesight DDNS.
- 2) Make sure that the internal and the external port number of RTSP are the same.

Email

Alarm video files can be sent to specific mail account through SMTP server. You must configure the email settings correctly before using it.

User Name:	<input type="text" value="hdipnc"/>
Sender Email Address:	<input type="text" value="hdipnc@sina.com"/>
Password:	<input type="password" value="*****"/>
SMTP Server:	<input type="text" value="smtp.sina.com"/>
SMTP Port:	<input type="text" value="25"/>
Recipient Email Address1:	<input type="text" value="user@domain.com"/>
Recipient Email Address2:	<input type="text"/>
Encryption:	<input type="radio"/> SSL <input type="radio"/> TLS

Table 4-4-13 Description of the buttons

Parameters	Function Introduction
User Name	The sender's name. It is usually the same as the account name
Sender Email Address	Email address to send video files attached emails
Password	The password of the sender
SMTP Server	The SMTP server IP address or host name(e.g. smtp.gmail.com)
SMTP Port	The port of SMTP server. The default TCP/IP port for SMTP is 25(not secured). For SSL/TLS port, it depends on the mail you use
Recipient Email Address1	Email address to receive video files
Recipient Email Address2	Email address to receive video files
Encryption	Check the checkbox to enable SSL or TLS if it is required by the SMTP server.

FTP

Alarm video files can be sent to specific FTP server. You must configure the FTP settings correctly before using it.

FTP Server Settings	
Server Address:	<input type="text" value="192.168.8.72"/>
Server Port:	<input type="text" value="21"/>
User Name:	<input type="text" value="admin"/>
Password:	<input type="password" value="*****"/>

FTP Storage Settings	
Storage Path:	<input type="text" value="Child Directory"/>
Parent Directory:	<input type="text" value="IP Address"/>
Child Directory:	<input type="text" value="Device Name"/>
Alarm Action File Name:	<input type="text" value="Customize"/>
Video File Name:	<input type="text" value="YYYY-MM-DD"/>
Image File Name:	<input type="text" value="YYYY-MM-DD"/>
Timing Snapshot File Name:	<input type="text" value="Default(YYYY-MM-DD)"/>

Table 4-4-14 Description of the buttons

Parameters	Function Introduction
Server Address	FTP server address
Server Port	The port of the FTP server. Generally it is 21
User Name	User name used to log in to the FTP sever
Password	User password
Storage Path	Storage Path where video and image will be uploaded to the FTP server. Four FTP storage path types are available, including Root Directory, Parent Directory, Child Directory and Customize.
Parent Directory	Choose IP Address/ Device Name/ Date as the folder name of Parent Directory, or customize the folder name.
Child Directory	Choose IP Address/ Device Name/ Date as the folder name of Child Directory, or customize the folder name.
Multilevel Folder Name	If the storage path is more than two levels, enter Multilevel FTP storage path here manually.
Alarm Action File Name	Choose the default(YYYY-MM-DD) or customize the alarm action file name.
Video File Name	If you choose to customize video file name, YYYY-MM-DD/ MM-DD-YYYY/ DD-MM-YYYY/ Add prefix are available.
Image File Name	If you choose to customize image file name, YYYY-MM-DD/ MM-DD-YYYY/ DD-MM-YYYY/ Add prefix are available.
Timing Snapshot File Name	Default(YYYY-MM-DD) /MM-DD-YYYY/ DD-MM-YYYY/ Add prefix/ Overwrite with the base file name are available.

Note:

Parent Directory will be under Root Directory, and Child Directory will be under Parent Directory.

VLAN

A virtual LAN (VLAN) is any broadcast domain that is partitioned and isolated in a computer network at the data link layer (OSI layer 2). LAN is an abbreviation of local area network. VLANs allow network administrators to group hosts together even if the hosts are not on the same network switch. This can greatly simplify network design and deployment, because VLAN membership can be configured through software. Without VLANs, grouping hosts according to their resource needs necessitates the labour of relocating nodes or rewiring data links.

VLAN Enable:	<input checked="" type="checkbox"/>
VLAN ID(1~4094):	<input type="text" value="1"/>
VLAN IP:	<input type="text"/>
VLAN Netmask:	<input type="text"/>
VLAN Gateway:	<input type="text"/>

[Save](#)

Note:

How to set up VLAN in switches, please refers to your switches user manual.

PPPoE

This camera supports the PPPoE auto dial-up function. The camera gets a public IP address by ADSL dial-up after the camera is connected to a modem. You need to configure the PPPoE parameters of the network camera.

Enable PPPoE:	<input checked="" type="checkbox"/>
Dynamic IP:	<input type="text" value="0.0.0.0"/>
User Name:	<input type="text"/>
Password:	<input type="text"/>
Confirm Password:	<input type="text"/>

[Save](#)

Note:

- 1) The obtained IP address is dynamically assigned via PPPoE, so the IP address always changes after rebooting the camera. To solve the inconvenience of the dynamic IP, you need to get a domain name from the DDNS provider (e.g. DynDns.com).
- 2) The user name and password should be assigned by your ISP.

SNMP

You can set the SNMP function to get camera status, parameters and alarm related information and manage the camera remotely when it is connected to the network.

Before setting the SNMP, please download the SNMP software and manage to receive the camera information via SNMP port. By setting the Trap Address, the camera can send the alarm event and exception messages to the surveillance center.

SNMP v1/v2	
SNMP V1 Enable:	<input type="checkbox"/>
SNMP V2c Enable:	<input type="checkbox"/>
Write Community:	<input type="text" value="public"/>
Read Community:	<input type="text" value="private"/>
SNMP v3	
SNMP V3 Enable:	<input type="checkbox"/>
Read Security Name:	<input type="text"/>
Level of Security:	<input type="text" value="no auth,no priv"/>
Write Security Name:	<input type="text"/>
Level of Security:	<input type="text" value="no auth,no priv"/>
SNMP Port	
SNMP Port:	<input type="text" value="161"/>

Table 4-4-15 Description of the buttons

Parameters	Function Introduction
SNMP v1/2/3	The version of SNMP, please select the version of your SNMP software. SNMP v1: Provide no security SNMP v2: Require password for access SNMP v3: Provide encryption and the HTTPS protocol must be enabled
Write Community	Input the name of Write Community
Read Community	Input the name of Read Community
Trap Address	Set the trap address
Trap Port	Set the trap port, the default is 162
Trap Community Name	Input the trap community name
Read Security Name	Input the name of Read Security Community
Level of Security	There are three levels available: (auth, priv), (auth, no priv) and (no auth, no priv)

Write Security Name	Input the name of Write Security Community
Level of Security	There are three levels available: (auth, priv), (auth, no priv) and (no auth, no priv)
SNMP Port	The port of SNMP, the default is 161

Note:

- 1) The settings of SNMP software should be the same as the settings you configure here;
- 2) A reboot is required for the settings to take effect.

802.1x

The IEEE 802.1X standard is supported by the network cameras, and when the feature is enabled, the camera data is secured and user authentication is needed when connecting the camera to the network protected by the IEEE 802.1X.

Enable 802.1x:	<input checked="" type="checkbox"/>
Protocol:	EAP-MD5
Eapol Version:	1
User Name:	<input type="text"/>
Password:	<input type="text"/>
Confirm Password:	<input type="text"/>

[Save](#)

4.4.5 Date&Time

Current System Time	
Date:	05/02/2018
Time:	11:24:24
Set the System Time	
Time Zone:	8 China (Beijing, Taipei)
Daylight Saving Time:	Disabled
NTP Sync:	<input checked="" type="checkbox"/> Interval: 1 day
<input type="radio"/> Synchronize with computer time	
Date:	05/02/2018
Time:	11:24:22
<input type="radio"/> NTP server	
<input type="radio"/> Manual	

[Save](#)

Current System Time

Current date&time of the system

Set the System Time

Table 4-4-16 Description of the buttons

Parameters	Function Introduction
Time Zone	Choose a time zone for your location.
Daylight Saving time	Enable the daylight saving time.
NTP Sync	Regularly update your time according to the interval time.
Synchronize with computer time	Synchronize the time with your computer.
NTP server	Input the address of NTP server.
Encryption Type	Synchronize the time with configured SNTP server and select time zone.
Manual	Set the system time manually.

4.5 Advanced Settings

4.5.1 Alarm

Motion Detection

Step1: Check the checkbox to enable the motion detection;

Step2: Set motion region;

Enable Motion Detection:

Onvif Motion ActiveCells Settings: Normal

Set Motion Region

Select All
Clear All

Note: Please draw the screen for setting!

Sensitivity
5

Table 4-5-1 Description of the buttons

Parameters	Function Introduction
Enable Motion Detection	Check the checkbox to enable Motion Detection function.
Onvif Motion ActiveCells Settings	Normal and Compatible are available for the option. If the setting of motion region of the third-party software is different from ours, please set this option to Compatible.
Select All	Click the button, and the motion in the area will be detected.
Clear All	Click the button, and the area drawn before will be removed.
Sensitivity	Sensitivity level, 1~10

Step3: Set motion detection schedule;

Schedule Settings

[Edit](#)

Step4: Set alarm action;

Alarm Action

Save Into Storage:	<input type="checkbox"/> File Format: Record v <small>(Please mount storage device.)</small>
Upload Via FTP:	<input type="checkbox"/> File Format: Record v
Upload Via SMTP:	<input type="checkbox"/> File Format: Snapsho v
External Output:	<input type="checkbox"/> (Please configure the External Output Action Time.)
Play Audio:	<input type="checkbox"/> (Please configure the Audio Action Settings and Audio Interval.)
Alarm to SIP Phone:	<input type="checkbox"/> (Please open the SIP.)
HTTP Notification:	<input type="checkbox"/>
White LED:	<input type="checkbox"/>
PTZ Motion:	<input type="checkbox"/>

Table 4-5-2 Description of the buttons

Parameters	Function Introduction
Save Into Storage	Save alarm recording files into SD Card or NAS
Upload Via FTP	Upload the recording files via FTP.
Upload Via SMTP	Upload the files via SMTP.
External Output	If the camera equips with External Output, you can enable the action after configuring the trigger duration.
Play Audio	If the camera equips with Speaker, you can enable the action after configuring the audio speaker.
Play Buzzer	If the camera equips with Buzzer, you can check the checkbox to enable the function.
Alarm to SIP Phone	Support to call the SIP phone after enable the SIP function.
HTTP Notification	Support to pop up the alarm news to specified HTTP URL. Note: Three HTTP notifications at most can be added to the same event.
White LED	When the alarm triggered, White LED will turn on to warning the detected objects (Only for Mini PTZ Bullet).
PTZ Motion	When the motion alarm triggered, PTZ Motion allows the camera move the lens to the motion triggered position and zoom in.
Call Preset/ Call Patrol/Call Pattern (only for External Input)	When the motion alarm triggered, the specified preset/patrol/pattern can be called.

NOTE:

- 1) The **HTTP notification** function is just one way for camera to send messages to VMS Software. And it's the VMS that defines what the messages mean and decides what to do after receiving this kind of messages. So, we can use the **HTTP Notification** function of our cameras only if the VMS supports this kind of message format.

Here the Digifort will be taken as an example to introduce the **HTTP Notification** function.

The following are the detail steps of setting for HTTP Notification in Digifort VMS and our cameras.

Step1: Enable Alarm; set Motion Region and Detection Schedule;

Step2: Confirm the HTTP Notification as Alarm Action, and fill the fields. Then save the alarm setting. You can add up to three HTTP notifications to the same event;

HTTP Notification:	<input checked="" type="checkbox"/>
HTTP Notification URL:	URL 1
Enable:	<input checked="" type="checkbox"/>
Trigger Interval:	5 (0-900) s
URL:	192.168.8.75:8601/Interface/Cameras/MotionDetection/Notify?Camera=annie
User Name:	admin
Password:	••••••••

HTTP User Name: admin (the user name of your camera)

HTTP Password: ms1234 (the password of your camera)

HTTP Notification URL:

<http://IP:8601/Interface/Cameras/MotionDetection/Notify?Camera=CameraName>

IP refers to the PC's IP where the Digifort installed.

8601 is the port for Motion signal in Digifort.

CameraName is the camera name you set in Digifort VMS, like the picture shown below.

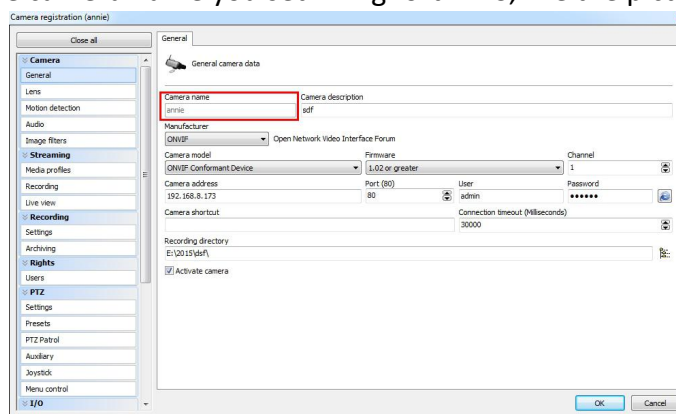

Example:

<http://192.168.8.75:8601/Interface/Cameras/MotionDetection/Notify?Camera=annie>,

this url format is exactly supported by Digifort VMS, so we can set as above to our cameras and get it work well.

Step3: Choose use motion detection by external notification;

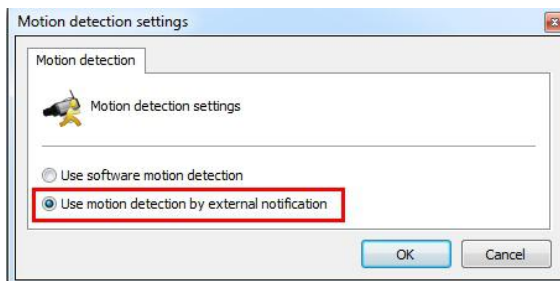

Step4: If successful, you can see the device icon turn yellow in the Surveillance when the camera is under Motion Detection Alarm;



So, it's the VMS Software which decides whether we can use this function successfully.
 Step5: Set alarm settings.

Alarm Setting	
Record Video Sections:	5 seconds <input type="button" value="v"/>
Pre-record:	0 second <input type="button" value="v"/>
Snapshot:	3 <input type="button" value="v"/>
Snapshot Interval:	1 <input type="text"/> second <input type="button" value="v"/>
External Output Action Time:	30 seconds <input type="button" value="v"/>
Audio Action Settings:	<input type="button" value="Edit"/>
Play Audio Interval:	Auto <input type="button" value="v"/>
White LED Flash Mode:	Twinkle <input type="button" value="v"/>
White LED Flash Time:	<input type="text" value="3"/> <input type="range"/> <input type="button" value="Reset"/>
White LED Effective Mode:	Always <input type="button" value="v"/>
Proportional Zoom Times:	2X <input type="button" value="v"/>
PTZ Motion Recovery Time:	3 seconds <input type="button" value="v"/> (Recovery time is not less than flash time.)

Table 4-5-3 Description of the buttons

Parameters	Function Introduction
Record Video Sections	Six different periods are available(5, 10, 15, 20, 25, 30 sec).
Pre-record	Reserve the record time before alarm, 0~10 sec.
Snapshot	The number of snapshot, from 1 to 5.
Snapshot Interval	It cannot be edited unless you choose more than 1 to Snapshot.
External Output Action Time	Length of time an alarm lasts, this cannot be edited unless when you enable the External Output on the Alarm Action firstly.
Audio Action Settings	Set the audio schedule to trigger different audio files and action times in different time, which is corresponded to alarm action.
Play Audio Interval	Auto/ 10 seconds/ 30 seconds/ 1 minute/ 5 minutes/ 10 minutes are available.
White LED Flash Mode	Twinkle: The White LED will continuous flashing before recovered; Always: The White LED will always open before recovered.

White LED Flash Time	The duration of flash. Twinkle from 1 second to 10 seconds; Always from 1 second to 60 seconds.
Proportional Zoom Times	Support to zoom proportionally when PTZ Motion is triggered.
PTZ Motion Recovery Time	The duration of one alarm. It must be longer than flash time.

Note:

- 1) Recovery time should not be less than flash time.
- 2) You can customize the schedule of Audio Action.

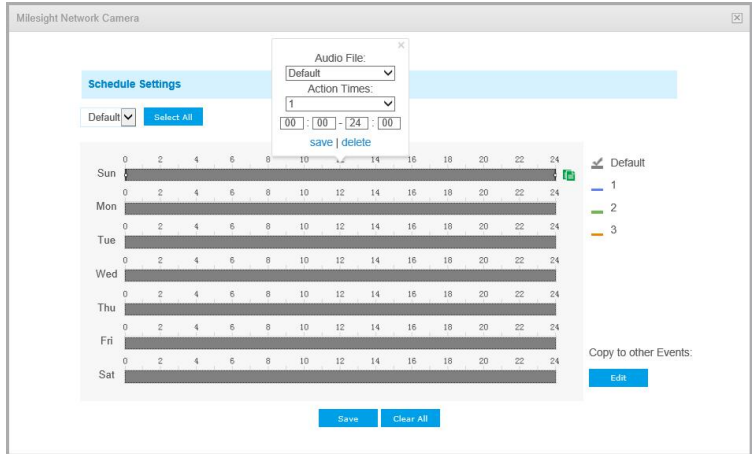

Audio Alarm

Enable the Audio before using Audio Alarm function.

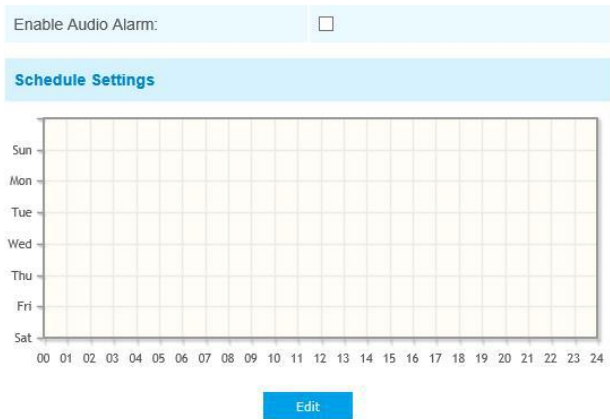

Alarm Action	
Save Into Storage:	<input type="checkbox"/> File Format: Record (Please mount storage device.)
Upload Via FTP:	<input type="checkbox"/> File Format: Record
Upload Via SMTP:	<input type="checkbox"/> File Format: Snapsho
External Output:	<input type="checkbox"/> (Please configure the External Output Action Time.)
Play Audio:	<input type="checkbox"/> (Please configure the Audio Action Settings and Audio Interval.)
Alarm to SIP Phone:	<input type="checkbox"/> (Please open the SIP.)
HTTP Notification:	<input type="checkbox"/>
White LED:	<input type="checkbox"/>
PTZ Motion:	<input type="checkbox"/>

Alarm Setting	
Record Video Sections:	5 seconds
Pre-record:	0 second
Snapshot:	3
Snapshot Interval:	1 second
External Output Action Time:	30 seconds
Audio Action Settings:	Edit
Play Audio Interval:	Auto
White LED Flash Mode:	Twinkle
White LED Flash Time:	<input type="range" value="3"/> Reset
White LED Effective Mode:	Always
Proportional Zoom Times:	2X
PTZ Motion Recovery Time:	3 seconds (Recovery time is not less than flash time.)

Please refer to table 4-5-2 and 4-5-3 to get the meaning of items.

External Input

Enable External Input:	<input type="checkbox"/>
------------------------	--------------------------

Schedule Settings	
	Edit

Alarm Action	
Save Into Storage:	<input type="checkbox"/> File Format: Record <input type="button" value="v"/> (Please mount storage device.)
Upload Via FTP:	<input type="checkbox"/> File Format: Record <input type="button" value="v"/>
Upload Via SMTP:	<input type="checkbox"/> File Format: Snapsho <input type="button" value="v"/>
External Output:	<input type="checkbox"/> (Please configure the External Output Action Time.)
Play Audio:	<input type="checkbox"/> (Please configure the Audio Action Settings and Audio Interval.)
Alarm to SIP Phone:	<input type="checkbox"/> (Please open the SIP.)
HTTP Notification:	<input type="checkbox"/>
White LED:	<input type="checkbox"/>
PTZ Motion:	<input type="checkbox"/>

Alarm Setting	
Record Video Sections:	5 seconds <input type="button" value="v"/>
Pre-record:	0 second <input type="button" value="v"/>
Snapshot:	3 <input type="button" value="v"/>
Snapshot Interval:	1 <input type="text"/> second <input type="button" value="v"/>
External Output Action Time:	30 seconds <input type="button" value="v"/>
Audio Action Settings:	<input type="button" value="Edit"/>
Play Audio Interval:	Auto <input type="button" value="v"/>
White LED Flash Mode:	Twinkle <input type="button" value="v"/>
White LED Flash Time:	<input type="range" value="3"/> <input type="button" value="Reset"/>
White LED Effective Mode:	Always <input type="button" value="v"/>
Proportional Zoom Times:	2X <input type="button" value="v"/>
PTZ Motion Recovery Time:	3 seconds <input type="button" value="v"/> (Recovery time is not less than flash time.)

The meaning of items please refer to table 4-5-2 and 4-5-3, here will not repeat again.

Other Alarm

Alarm Type	Network Lost
Enable Network Lost Alarm:	<input type="checkbox"/>
Alarm Action	
Save Into SD Card:	<input type="checkbox"/> File Format: AVI (Please insert SD card.)
External Output:	<input type="checkbox"/> (Please configure the External Output Action Time.)
Play Audio:	<input type="checkbox"/> (Please enable the Audio Speaker.)
White LED:	<input type="checkbox"/>
Alarm Setting	
Record Video Sections:	5 seconds
Pre-record:	0 second
Snapshot:	1
Snapshot Interval:	1 second
External Output Action Time:	30 seconds
Audio Action Settings:	Edit
Play Audio Interval:	Auto
White LED Flash Mode:	Twinkle
White LED Flash Time:	3 Reset
White LED Effective Mode:	Always
Save	

Table 4-5-4 Description of the buttons

Parameters	Function Introduction
Alarm Type	<p>Network Lost, Tampering and IP Address Conflicted are available Check the checkbox to enable the alarm type you selected</p>
Alarm Action	<p>Save Into SD Card: Save alarm recording files into SD Card External Output: If the camera equips with External Output, you can enable the action after configuring the trigger duration Play Audio: If the camera equips with Speaker, you can enable the action after configuring the audio speaker Play Buzzer: If the camera equips with Buzzer, you can check the checkbox to enable the function White LED: The White LED could flash as a warning signal when the alarm triggered if the camera equipped with it(only for Mini PTZ Bullet).</p>

Alarm Setting	<p>Record Video Sections: Six different periods are available(5, 10, 15, 20, 25, 30 sec)</p> <p>Pre-record: Reserve the record time before alarm, 0~10 sec</p> <p>Snapshot: The number of snapshot, 1~5</p> <p>Snapshot Interval: This cannot be edited unless you choose more than 1 to Snapshot</p> <p>Trigger Duration: Length of time an alarm lasts, this cannot be edited unless when you enable the External Output on the Alarm Action firstly</p> <p>Audio Action Settings: Set the audio schedule to trigger different audio files and action times in different time, which is corresponded to alarm action</p> <p>Play Audio Interval: Auto/10 seconds/30 seconds/1 minute/5 minutes/10 minutes are available</p> <p>White LED Flash Mode: Twinkle and Always are available.</p> <p>White LED Flash Time: The duration of flash. Twinkle from 1 second to 10 seconds; Always from 1 second to 60 seconds.</p> <p>White LED Effective Mode: Always, Light Environment and Customize are available. Always Mode allows to keep White LED always on. Light Environment Mode allows to set the Effective Light Intensity to turn on White LED basing on Current Light Intensity. Customize Mode allows to set the start time and the end time to control White LED.</p>
----------------------	---

External Output

External Output	
Normal Status:	<input type="radio"/> Open <input checked="" type="radio"/> Grounded
Current Status:	Grounded
<input type="button" value="Test"/> <input type="button" value="Save"/>	

Please set the **Normal Status** firstly, when the **Current Status** is different with **Normal Status**, it will lead to the alarm.

4.5.2 Storage

Before you start:

To configure record settings, please make sure that you have the network storage device within the network or the SD card inserted in your camera.

Choose the storage mode according to your needs.

Storage Management

SD Card:

SD Card Settings			
Total Size:0M	Free Size:0M	Used Size:0M	<input type="button" value="Format"/>

Note: Please insert SD card.

Table 4-5-5 Description of the buttons

Parameters	Function Introduction
Format	Format SD card, the files in SD card will be removed
Mount/UnMount	Mount/Dismount SD card
Delete	Enable cyclic storage, when the free disk space reach at a certain value, it will automatically delete the files at certain percentage according to your settings

NAS

The network disk should be available within the network and properly configured to store the recorded files, etc.

NAS (Network-Attached Storage), connecting the storage devices to the existing network, provides data and files services.

NAS Settings

Server Address:

File Path:

Mounting Type:

NFS ▼

Add

Table 4-5-6 Description of the buttons

Parameters	Function Introduction
Server Address	IP address of NAS server
File Path	Input the NAS file path, e.g. “\path”.
Mounting Type	NFS and SMB/CIFS are available. And you can set the user name and password to guarantee the security if SMB/CIFS is selected

Note:

Up to 5 NAS disks can be connected to the camera.

Record Settings

Storage Settings

Enable Recycle Storage:

[Save](#)

Schedule Settings

Sun																									
Mon																									
Tue																									
Wed																									
Thu																									
Fri																									
Sat																									
	00	01	02	03	04	05	06	07	08	09	10	11	12	13	14	15	16	17	18	19	20	21	22	23	24

[Edit](#)

Table 4-5-7 Description of the buttons

Parameters	Function Introduction
Enable Recycle Storage	Enable/Disable Recycle Storage, if you enable this option, it will delete the files when the free disk space reach a certain value.
Schedule Settings	Click the Edit button to edit record schedule

Note:

SD Card or NAS are available.

Snapshot Settings

Snapshot Settings

Enable Timing Snapshot:

Interval: hour ▼

Save Into Storage: (Please mount storage device.)

File Name: ▼

Upload Via FTP:

Upload Via SMTP:

[Save](#)

Schedule Settings

Sun																									
Mon																									
Tue																									
Wed																									
Thu																									
Fri																									
Sat																									
	00	01	02	03	04	05	06	07	08	09	10	11	12	13	14	15	16	17	18	19	20	21	22	23	24

[Edit](#)

Table 4-5-8 Description of the buttons

Parameters	Function Introduction
Snapshot Settings	<p>Enable Timing Snapshot: Check the checkbox to enable the Timing Snapshot function</p> <p>Interval: Set the snapshots interval, input the number and choose the unit(millisecond, second, minute, hour, day)</p> <p>Save Into Storage: Save the snapshots into SD card or NAS, and choose the file name to add time suffix or overwrite the base file name.</p> <p>Save Into NAS: Save the snapshots into NAS, and choose the file name to add time suffix or overwrite the base file name</p> <p>Upload Via FTP: Upload the snapshots via FTP</p> <p>Upload Via SMTP: Upload the snapshots via SMTP</p> <p>Please note:</p> <p>If you choose to add time suffix, every snapshot picture will be saved, but if you choose to overwrite the base file name, only one latest picture will be saved. When you choose add overwrite the base file name to SD Card or NAS, it will create a file named "Snapshot" to place the snapshot.</p>
Schedule Settings	Click the Edit button to edit record schedule

Explorer

Files will be seen on this page when they are configured to save into SD card or NAS. You can set time schedule every day for recording videos and save video files to your desired location.

(Note: Files are visible once SD card is inserted. Don't insert or pull out SD card when power on.)

Video files are arranged by date. Set file type and start/end time to search out files. Each day files will be displayed under the corresponding date, from here you can copy and delete files etc. You can visit the files in SD card by ftp, for example, <ftp://username:password@192.168.5.190>(user name and password are the same as the camera account and the IP followed is the IP of your device.).

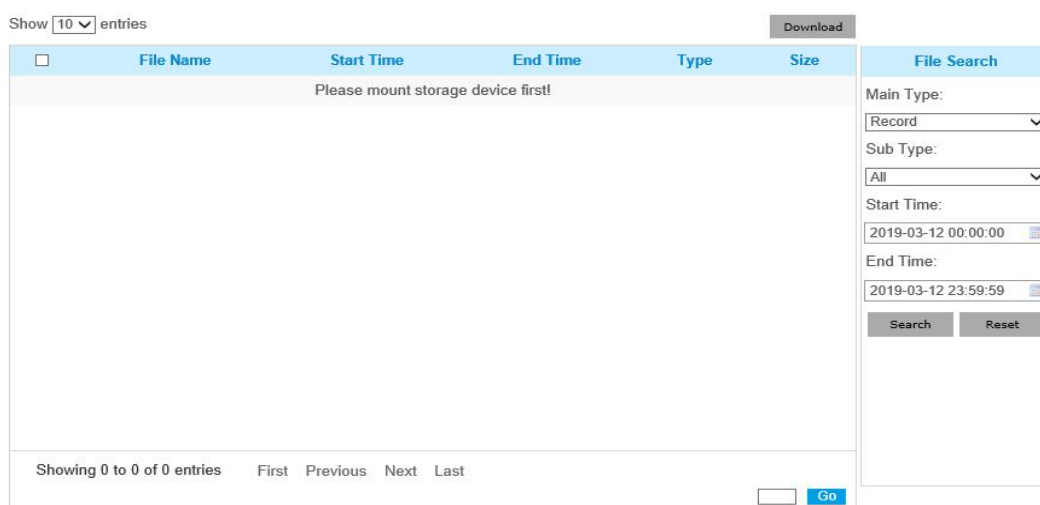

4.5.3 Security

User

Manage Privilege

Allow Anonymous Viewing:

Security Question

Security Question: Edit

Account Management

Add
Edit
Delete

ID	User Name	Privilege
1	admin	Administrator
2	milesight	Operator

Admin Password:

User Level: Operator ▼

User Name:

Password:

Confirm:

Note: You can only add 20 users

Save
Clear

Table 4-5-9 Description of the buttons

Parameters	Function Introduction
Manage Privilege	Allow anonymous viewing: Check the checkbox to enable visit from whom doesn't have account of the device
Security Question	Click "Edit" button to set three security questions for your camera. In case that you forget the password, you can click "Forget Password" button on login page to reset the password by answering three security questions correctly.

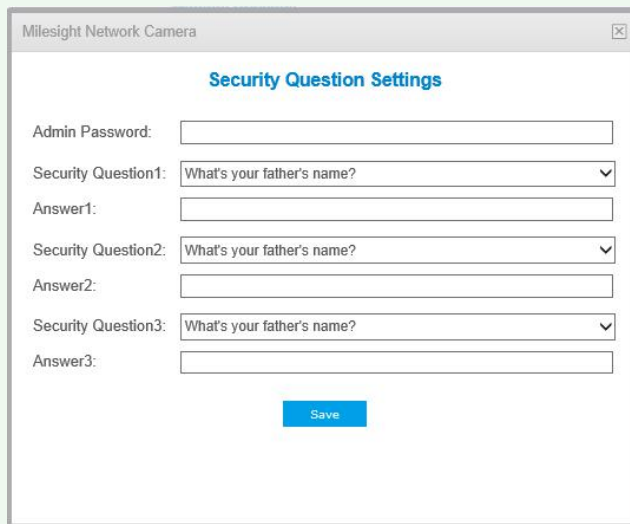

There are twelve default questions below, you can also customize the security questions.



<p>Account Management</p>	<p>Click "Add" button, it will display Account Management page. You can add an account to the camera by entering the following information. The added account will be displayed in the account list. You can edit and delete the account in the account list (except the admin account).</p> <p>Admin Password: You can only add an account after you enter the correct admin password.</p> <p>User Level: Set the privilege for the account.</p> <p>User Name: Input user name for creating an account</p> <p>Password: Input password for the account</p> <p>Confirm: Confirm the password</p>
<p>Administrator</p>	<p>An administrator can manage all configuration pages of the device, including change user password, add or delete users (the default user "admin" cannot be deleted)</p>
<p>Operator</p>	<p>An operator can manage all configuration pages except the User page</p>
<p>Viewer</p>	<p>A viewer can't change any settings</p>

Note:

- 1) For versions above 54, the Operator and Viewer users are closed by default. But you still can add on the User page.
- 2) You can only add 20 users.

3) For V4x.7.0.69 or above, it removes the default admin password and allows to set a password when logging in for the first time. It also supports set-up of the security questions for the devices. Users can reset the password by answering the correct security questions in case of forgetting the password, which is more convenient for users.

Access List

General Settings

Maximum Number of Concurrent Streaming:

IP Access List

Rule:

IP Address:

Enable Access List Filtering:

Filter Type: Allow Deny

Table 4-5-10 Description of the buttons

Parameters	Function Introduction
General Settings	Maximum number of concurrent streaming: Select the maximum number of concurrent streaming. Options include Number Limit, 1~9.
IP access list	Rule: Single, Network and Range are available; IP address: Input the address to get the access to the device.
Enable access list filtering	Able to access or restrict access for some IP address.
Filter type	Access or restrict access

Security Service

SSH Settings

Enable SSH:

SSH Port:

Table 4-5-11 Description of the buttons

Parameters	Function Introduction
SSH Settings	Secure Shell (SSH) has many functions: it can replace Telnet and also provides a secure channel for FTP, POP, even for PPP.

4.5.4 SIP

The Session Initiation Protocol(SIP) is a signaling communications protocol, widely used for controlling multimedia communication sessions such as voice and video calls over Internet Protocol(IP) networks. This page allows user to configure SIP related parameters. Milesight cameras can be configured as SIP endpoint to call out when alarm triggered; or allow permitted number to call in to check the video if the video IP phone is used. To use this function, the settings in SIP page must be configured properly. There are two ways to get video through SIP, one is to dial the IP address directly, the other is account registration mode. the details are as follows:

Method 1: IP Direct mode

Dial on the camera’s IP address directly through SIP phone, so you can see the video.

Note:

SIP phone and the camera should in the same network segment.

Method2: Account registration mode

- 1) Before using the SIP, you need to register an account for the camera from the SIP server;
- 2) Register another user account for the SIP device from the same SIP server;
- 3) Call the camera User ID from the SIP device, you will get the video on the SIP device.

SIP Settings

Unregistered

Enable:	<input checked="" type="checkbox"/>
Register Mode:	<input type="text" value="Enable"/>
User ID:	<input type="text" value="500"/>
User Name:	<input type="text" value="sipclient"/>
Password:	<input type="password" value="*****"/>
Server Address:	<input type="text" value="192.168.5.101"/>
Server Port:	<input type="text" value="5060"/>
Connection Protocol:	<input type="text" value="UDP"/>
Video Stream:	<input type="text" value="Tertiary Stream"/>
Max Call Duration:	<input type="text" value="1800"/> s (0 means no limitation.)

Note:SIP supports Direct IP call.

Table 4-5-12 Description of the buttons

Parameters	Function Introduction
------------	-----------------------

Unregistered/Registered	SIP registration status. Display “Unregistered” or “Registered”
Enable	Start or stop using SIP
Register Mode	Choose to use Enable mode or Disable mode. Enable mode means to use SIP with register account. Disable mode refers to use SIP without register account, just use the IP address to call.
User ID	SIP ID
User Name	SIP account name
Password	SIP account password
Server Address	Sever IP address
Server Port	Sever port
Connection Protocol	UDP/TCP
Video Stream	Choose the video stream
Max Call Duration	The max call duration when use SIP

Note: SIP supports Directly IP call.

Alarm Phone List

Phone Type:	<input type="text" value="Phone Number"/>
To Phone Number:	<input type="text"/>
Remark Name:	<input type="text"/>
Duration:	From <input type="text" value="00"/> : <input type="text" value="00"/> To <input type="text" value="24"/> : <input type="text" value="00"/>

Table 4-5-13 Description of the buttons

Parameters	Function Introduction
Phone Type	Phone Number(Call by phone number) & Direct IP Call(Check to accept peer to peer IP call).
To Phone Number/ IP Address	Call by phone number or IP address.
Remark Name	Display name.
Duration	The time schedule to use SIP.

White List

Table 4-5-14 Description of the buttons

Parameters	Function Introduction
Phone Type	Phone Number(Call by phone number) & Direct IP Call
Phone Number/ IP Address	Including the phone number or IP address on the white list
Enable White List Number Filter	When enabled, it can only visited by the designated phone number or IP address.

4.5.5 Smart Event

Smart Event uses Milesight Video Content Analysis technology. This technical capability is used in a wide range of domains including entertainment, health-care, retail, automotive, transport, home automation, safety and security. Milesight VCA provides advanced, accurate smart video analysis for Milesight network cameras. It enhances the performance of network cameras through 10 detection modes which are divided into basic function and advanced function, enabling the comprehensive surveillance function and quicker response of cameras to different monitoring scenes. **(Note: Please ask license from Milesight sales)**

Region Entrance

Region entrance helps to protect a special area from potential threat of suspicious person's or object's entrance. An alarm will be triggered when objects enter the selected regions by enabling region entrance.

Advanced Settings >> Smart Event

Region Entrance

Region Exiting

Advanced Motion Detection

Tamper Detection

Line Crossing

Loitering

Human Detection

People Counting

Object Left/Removed

Settings

Enable Region Entrance Detection:

Effective Region Settings: Normal

Set Entrance Detection Region



Select All
Clear All

Note: Please draw the screen for setting!

Schedule Settings

Sun

- Step1: Set entrance detection region. If you choose **Normal Mode**, it supports configuring the detection region for the current area. If you choose **Advanced Mode**(Only for PTZ series), it supports configuring the detection region for different PTZ presets(Only support Preset 1~4 so far).
- Step2: Set detection schedule;
- Step3: Set alarm action;
- Step4: Set alarm settings.

Region Exiting

Region exiting is to make sure that any person or object won't exit the area that is being monitored. Any exit of people or objects will trigger an alarm.

Advanced Settings >> Smart Event

Region Entrance

Region Exiting

Advanced Motion Detection

Tamper Detection

Line Crossing

Loitering

Human Detection

People Counting

Object Left/Removed

Settings

Enable Region Exiting Detection:

Effective Region Settings: Normal

Set Exiting Detection Region



Select All
Clear All

Note: Please draw the screen for setting!

Schedule Settings

Sun

- Step1: Set exiting detection region. If you choose **Normal Mode**, it supports configuring the detection region for the current area. If you choose **Advanced Mode**(Only for PTZ series), it supports configuring the detection region for different PTZ presets(Only support Preset 1~4 so far).
- Step2: Set detection schedule;
- Step3: Set alarm action;

Step4: Set alarm settings.

Advanced Motion Detection

Different from traditional motion detection, Milesight advanced motion detection can filter out “noise” such as lighting changes, natural tree movements, etc. When an object moves in the selected area, it will trigger alarm.

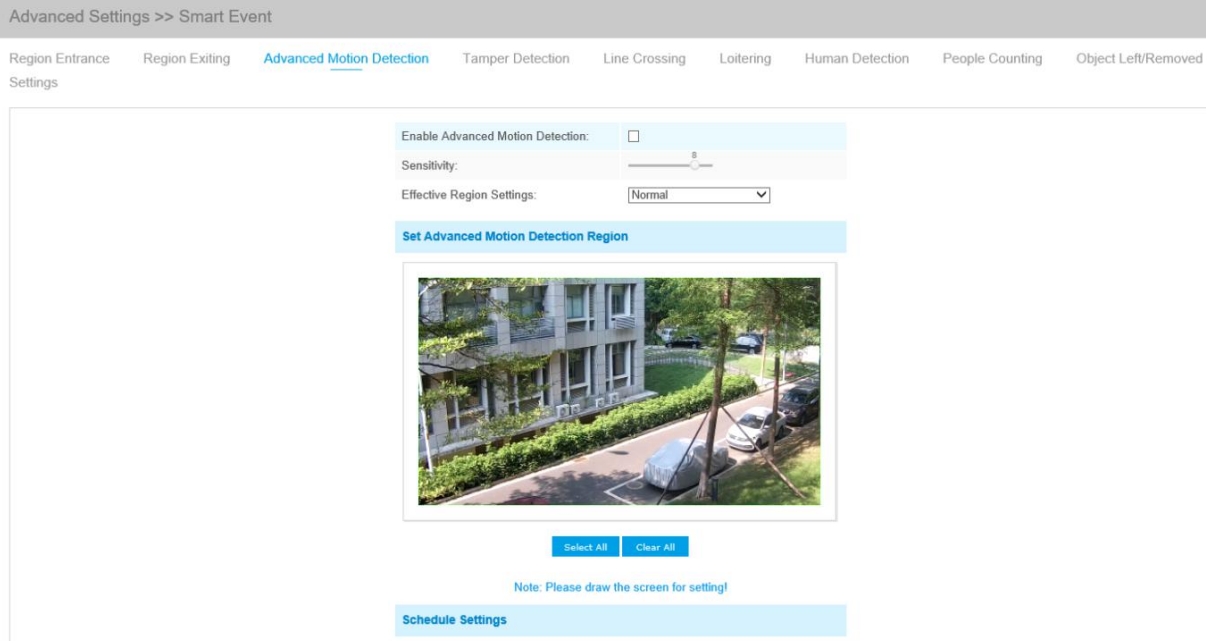

Step1: Set detecting sensitivity;

Step2: Set advanced motion detection region. If you choose **Normal Mode**, it supports configuring the detection region for the current area. If you choose **Advanced Mode**(Only for PTZ series), it supports configuring the detection region for different PTZ presets(Only support Preset 1~4 so far).

Step3: Set detection schedule;

Step4: Set alarm action;

Step5: Set alarm settings.

Note:

The sensitivity can be configured to detect various movement according to different requirements. When the level of sensitivity is low, slight movement won't trigger the alarm.

Tamper Detection

Tamper Detection is used to detect possible tampering like the camera being unfocused, obstructed or moved. This functionality alerts security staff immediately when any above-mentioned actions occur.

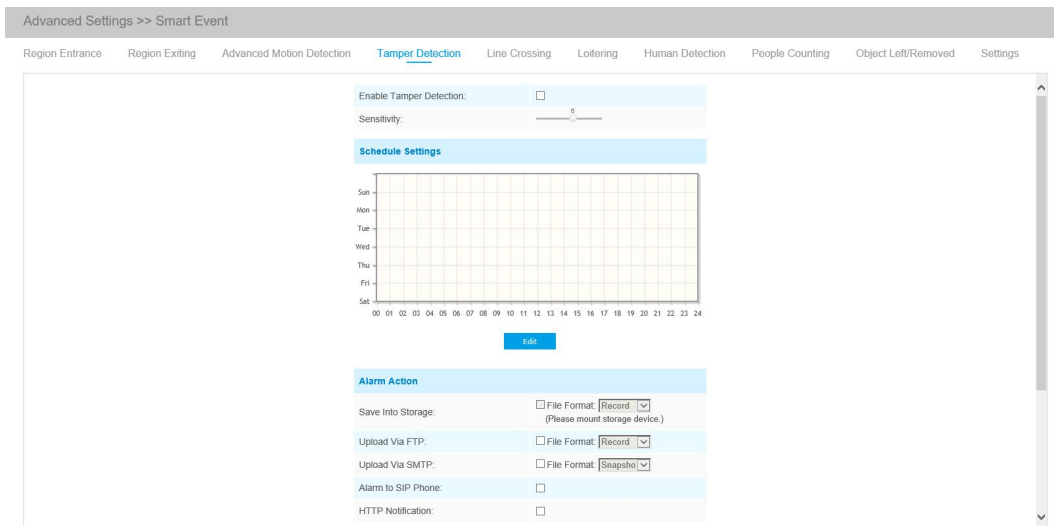

- Step1: Set detecting sensitivity;
- Step2: Set detection schedule;
- Step3: Set alarm action;
- Step4: Set alarm settings.

Line Crossing

Line Crossing detection is designed to work in most indoor and outdoor environment. An event will be triggered every time when the camera detects objects crossing a defined virtual line.

Advanced Settings >> Smart Event

Region Entrance Region Exiting Advanced Motion Detection Tamper Detection **Line Crossing** Loitering Human Detection People Counting Object Left/Removed Settings

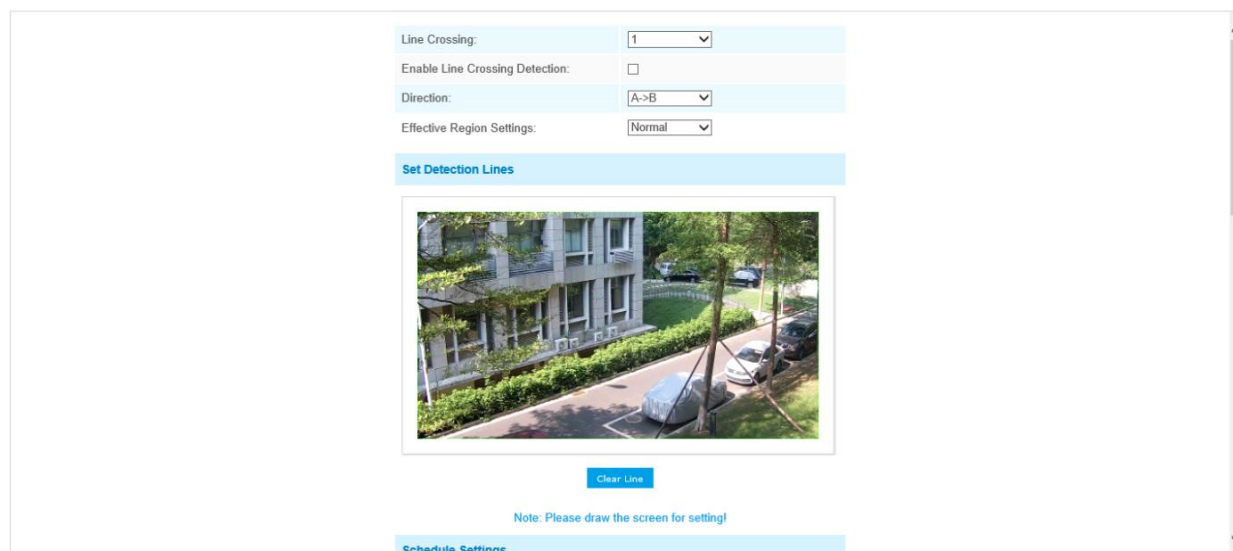

Settings steps are shown as follows:

Step1: Choose a line number;

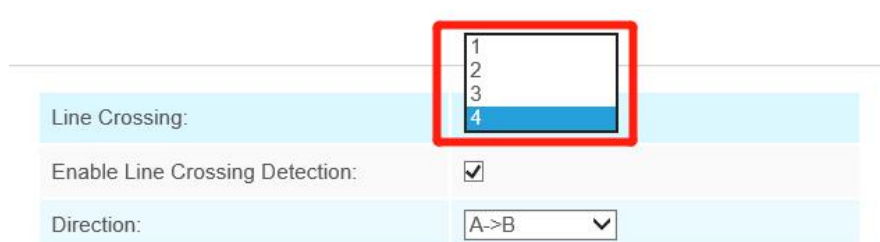

Step2: Enable Line Crossing Detection and define its direction;

Line Crossing:	4
Enable Line Crossing Detection:	<input checked="" type="checkbox"/>
Direction:	<div style="border: 1px solid red; padding: 2px;"> A->B B->A A<->B </div>
Set Detection Lines	

Step3: Draw detection lines. If you choose **Normal Mode**, it supports configuring the detection lines for the current area. If you choose **Advanced Mode**(Only for PTZ series), it supports configuring different detection lines for different PTZ presets(Only support Preset 1~4 so far).

Step4: Set detection schedule;

Step5: Set alarm action;

Step6: Set alarm settings.

Note:

Milesight allows to set up to four lines at a time. There are three direction modes to choose for triggering alarm. "A→B" means when there is any object crossing the line from the "A" side to the "B" side, the alarm will be triggered. "B→A" vice versa. "A ↔ B" means that the alarm will be triggered when objects cross line from either side.

Loitering

When objects are loitering in a defined area for a specific period of time, it would trigger an alarm.

Advanced Settings >> Smart Event

Region Entrance
Region Exiting
Advanced Motion Detection
Tamper Detection
Line Crossing
Loitering
Human Detection
People Counting
Object Left/Removed

Enable Loitering Detection:	<input type="checkbox"/>
Min. Loitering Time:	<input type="text" value="7"/> (3~1800) s
Object Size:	<input type="text" value="30"/>
Effective Region Settings:	Normal

[Set Loitering Detection Region](#)



Select All
Clear All

Note: Please draw the screen for setting!

[Schedule Settings](#)

Step1: Set minimum loitering time;

Step2: Set object size;

Step3: Set loitering detection region. If you choose **Normal Mode**, it supports configuring the detection region for the current area. If you choose **Advanced Mode**(Only for PTZ series), it supports configuring the detection region for different PTZ presets(Only support Preset 1~4 so far).

Step4: Set detection schedule;

Step5: Set alarm action;

Step6: Set alarm settings.

Note:

After setting minimum loitering time from 3s to 1800s, any objects loitering in the selected area over the minimum loitering time will trigger the alarm. Also Milesight loitering allows to set "Object Size". Only the object bigger than the set size will trigger the alarm.

Human Detection

Human detection is used for figuring out whether an object is a human or not. Once human detection is enabled, when there is an object appearing in the detecting area, an ID will show on the frame. If the object is a person, it will mark as "person". When the Show Tracks is enabled, the tracks of the moving object will show on the screen.

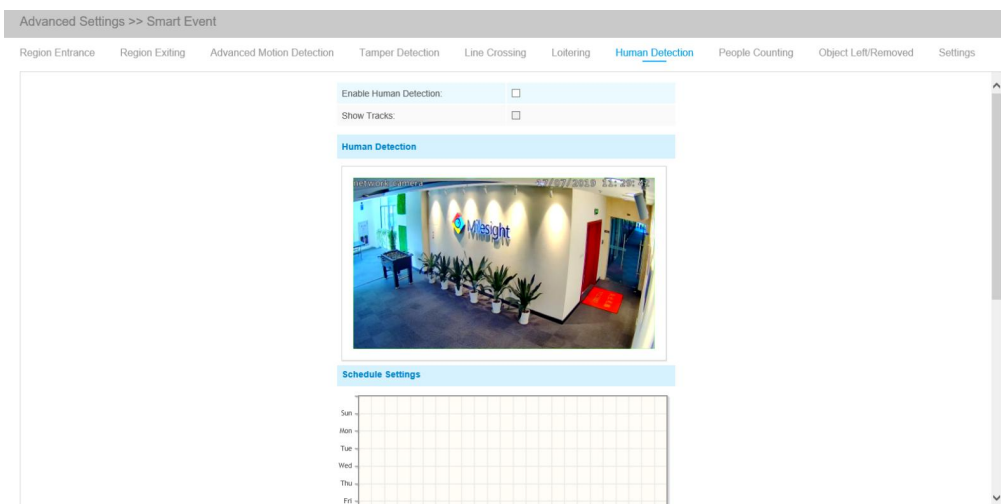

People Counting

People counting is able to count that how many people enter or exit during the setting period.

Advanced Settings >> Smart Event

Region Entrance Region Exiting Advanced Motion Detection Tamper Detection Line Crossing Loitering Human Detection **People Counting** Object Left/Removed Settings

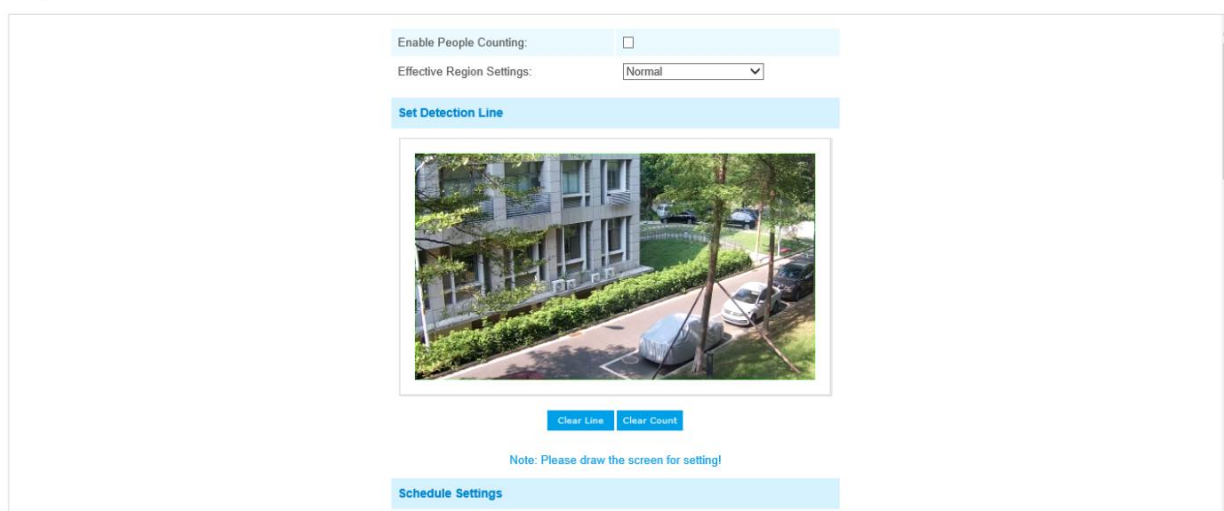

Step1: Set detection line. If you choose **Normal Mode**, it supports configuring the detection line for the current area. If you choose **Advanced Mode**(Only for PTZ series), it supports configuring the detection line for different PTZ presets(Only support Preset 1~4 so far).

Step2: Set detection schedule;

Step3: Set counting OSD;

Counting OSD	
Show Video Title:	<input checked="" type="checkbox"/>
Font Size:	Small
Font Color:	
Text Position:	Top-Left

The OSD of the people counting support automatic zeroing;

Enable Auto Reset:	<input checked="" type="checkbox"/>
Day:	Everyday
Time:	00:00:00

Step4: Click “Edit” to check the counting logs, the data log can be exported to FTP/ SMTP/ Storage automatically as an Excel spreadsheet according to the time interval and range you set;

Log Settings	
Logs:	Edit
Enable Auto Export Logs:	<input checked="" type="checkbox"/>
Day:	Everyday
Time:	00:00:00
Export Time Range::	All
Export to:	<input type="checkbox"/> FTP <input type="checkbox"/> SMTP <input type="checkbox"/> Storage

Step5: Set alarm trigger. Alarm will be triggered when the thresholds reaches to a certain value from 1 to 9999.

Alarm Trigger	
Enable Alarm	<input checked="" type="checkbox"/>
Thresholds:	<input type="checkbox"/> In: <input type="text" value="9999"/>
	<input type="checkbox"/> Out: <input type="text" value="9999"/>
	<input type="checkbox"/> Capacity: <input type="text" value="9999"/>
	<input type="checkbox"/> Sum: <input type="text" value="9999"/>

Step6: Set alarm action;

Step7: Set alarm settings.

Note:

Crossing along the direction of the arrow will record as “In”, opposite is “Out”;

Object Left/Removed(Optional)

Object Left can detect and prompt an alarm if an object is left in a pre-defined region. Object Removed can detect and prompt an alarm if an object is removed from a pre-defined region.

Advanced Settings >> Smart Event

Region Entrance Region Exiting Advanced Motion Detection Tamper Detection Line Crossing Loitering Human Detection People Counting **Object Left/Removed**

Enable Object Left:	<input type="checkbox"/>
Enable Object Removed:	<input type="checkbox"/>
Min. Time:	<input type="text" value="20"/> s
Effective Region Settings:	<input type="text" value="Normal"/>

Set Detection Region



Note: Please draw the screen for setting!

Step1: Enable Object Left or Object Removed(Or you can enable both features at the same time);

Step2: Set minimum time;

Step3: Set detection region. If you choose **Normal Mode**, it supports configuring the detection region for the current area. If you choose **Advanced Mode**(Only for PTZ series), it supports configuring the detection region for different PTZ presets(Only support Preset 1~4 so far).

Step4: Set detection schedule;

Step5: Set alarm action;

Step6: Set alarm settings.

Note:

1. After setting minimum time from 3s to 1800s, any objects are left in the selected area or removed from the selected area over the minimum time will trigger the alarm.
2. Object Left/Removed is optional, if you need this function, please contact Milesight sales first.

Setting

Milesight VCA provides the primary setting for the whole VCA functions. “Minimum Size” is to set the whether an object is big enough to trigger other settings. The frame you draw on the screen means that only if the object size is bigger than the frame, the settings for other VCA functions will take effect. Maximum Size means opposite, the frame you draw on the screen stands for that only if the object size is smaller than the frame, the settings for other VCA functions will take effect.

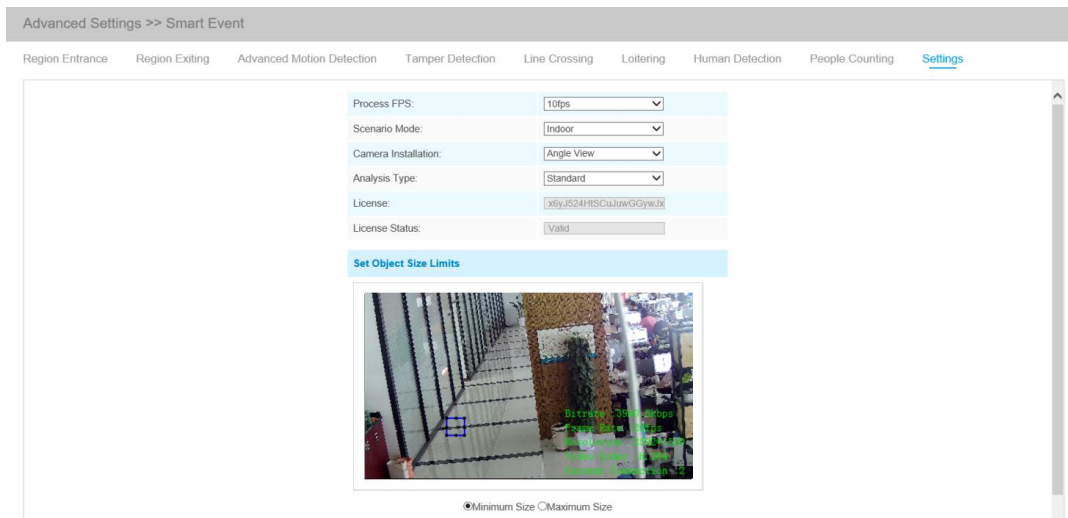

Table 4-5-15 Description of the buttons

Parameters	Function Introduction
Process FPS	Five different periods are available(5, 10, 15, 20, 25, fps) for process fps
Scenario Mode	Select Indoor or Outdoor mode to meet your needs
Camera Installation	Select camera installation view, including Angle View , Horizontal View and Overhead View
Analysis Type	Select Standard or Advanced analysis type
License	Generated by camera’s information
License Status	Show present license status, including Valid , Invalid , Expired , Unactivated
Minimum Size	Draw the screen or input pixel number to set the minimum size of the detected object. When the object is smaller than this size, it will not be detected. The default minimum size is 3*3.
Maximum Size	Draw the screen or input pixel number to set the maximum size of the detected object. When the object is larger than this size, it will not be detected. The default maximum size is 320*240.

4.5.6 PTZ

PTZ Settings provides you to configure the functions and parameters about Pan/Tilt/Zoom. PTZ parameters are mainly include the Basic parameters, Auto Home, PTZ Limits, Initial Position(Mini PTZ Bullet), Privacy Mask, Scheduled Tasks, Auto Tracking, Config Clear, RS485(Speed Dome).

Basic

PTZ OSD	
Zoom Status:	5 seconds
Pan & Tilt Status:	5 seconds
Preset Status:	5 seconds
Preset	
Preset Freezing:	<input type="checkbox"/>
Speed	
Preset Speed:	1
Patrol	
Patrol Recovering:	<input type="checkbox"/>
Patrol Recovery Time(5-720s):	10 s
Focus	
Focus Mode:	Semi-Auto
Power Off Memory	
Set Resume Time:	Disable

[Save](#)

Table 4-5-16 Description of the buttons

Parameters	Function Introduction
PTZ OSD	Configure the OSD parameter, and you can set the Zoom status OSD, Pan&Tilt Status , Preset Status with Close/ Always open/ 2s/ 5s/ 10s.
Preset	If you enabled Preset Freezing, the live view of preset position will be showed directly instead of showing both the moving path to the position and the live view. It can also reduce the use of bandwidth in the digital network system.
Speed	Preset Speed: It determines the speed of calling presets. Level 1~10 are available.
	Manual Speed: it only for Speed Dome, and it determines the PTZ speed of Manually control. Low/ Medium/ High are available. Scan Speed: it is only for Speed Dome, and it determines the speed of Auto Scan. Level 1~10 are available.
Patrol (Mini PTZ Bullet)	Patrol Recovering: Click to enable Patrol Recovering.
	Patrol Recovery Time: Set time for Patrol Recovering, which is between 5 and 720 seconds.
Focus	Focus Mode: Three focus modes are available: Auto/ Semi-Auto/ Manual.

	<p>Minimum focus Distance: Set the minimum focus distance to adjust the step length of each focus. 1 meter, 1.5 meters, 3 meters, 6 meters, 10 meters and 20 meters are available.</p> <p>Note: this option is only for Speed Dome.</p>
<p>Power Off Memory</p>	<p>If the camera stop working for a longer time than predefined, the position of it will be recorded. And it will resume to the position after going back to the normal work from power off. You can set the resume time to 30 seconds, 60 seconds, 300 seconds or 600 seconds to record its position.</p>

Auto Home



Enable:	<input checked="" type="checkbox"/>
Latency Time(5-720s):	<input type="text" value="10"/> s
Auto Home Mode:	<input type="text" value="Preset"/>
Auto Home Mode Number:	<input type="text" value="Current Location"/> <input type="button" value="Call"/>

Auto Home allows the PTZ camera to return to a predefined Home Position automatically after a period of latency time. Check the checkbox to enable the Auto Home mode.

Table 4-5-17 Description of the buttons

Parameters	Function Introduction
<p>Latency Time</p>	<p>Set a latency time to trigger Auto Home mode, 5-720s.</p>
<p>Auto Home Mode</p>	<p>Preset: A preset point will take effect when triggering the Auto Home.</p>
<p>Auto Home Mode Number</p>	<p>Select a predefined preset in the list, press “Call” to check the location. Also support to select current location.</p>

PTZ Limit

The PTZ camera can be programmed to move within the configurable PTZ Limits(Left/Right).

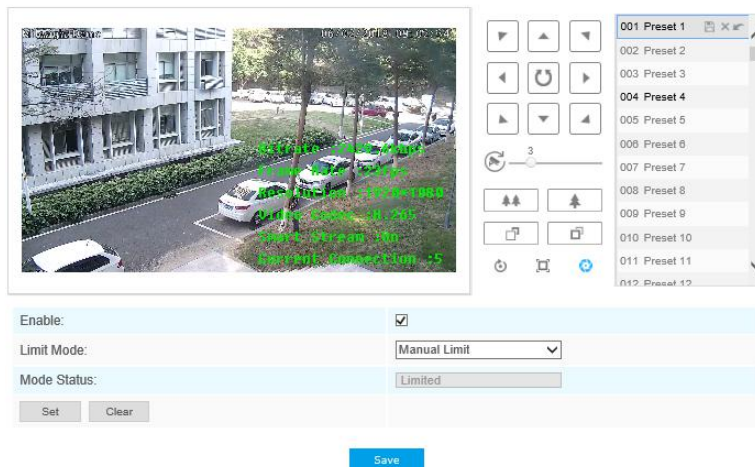

Step1: Check the checkbox to enable the PTZ Limit function.

Step2: Choose the limit mode as Manual limit or scanning limit.

- Manual Limit:

When Manual limit stops are set, you can operate the PTZ control panel manually only in the limited surveillance area.

- Scan Limit:

When Scan limit stops are set, the auto scan is performed only in the limited surveillance area.

Step3: Click the PTZ controller buttons to set the left/right limit stops; you can also call the defined presets and set them as the limits of the PTZ camera.

Step4: Click **Set** to save the limits or **Clear** to clear the limits.

Initial Position

You can configure the Initial Position for Mini PTZ Bullet as a zero point.

Step1: Click the PTZ control buttons as the Initial Position of the Mini PTZ bullet,you can also call a defined preset and set it as the Initial Position.

Step2: Click Set to save the position as the Initial Position.



Table 4-5-18 Description of the buttons

Parameters	Function Introduction
Set	Click to set the current position as a Initial Position
Clear	Clear the Initial Position to default settings.
Call	Click to call the Initial Position.

Note:

This function is only for Mini PTZ Bullet.

Privacy Mask

Privacy mask enables to cover certain areas on the live video to prevent certain spots in the surveillance area from being viewed and recorded. The mask area does not move as the lens moves. You can set 8 mask areas at most.

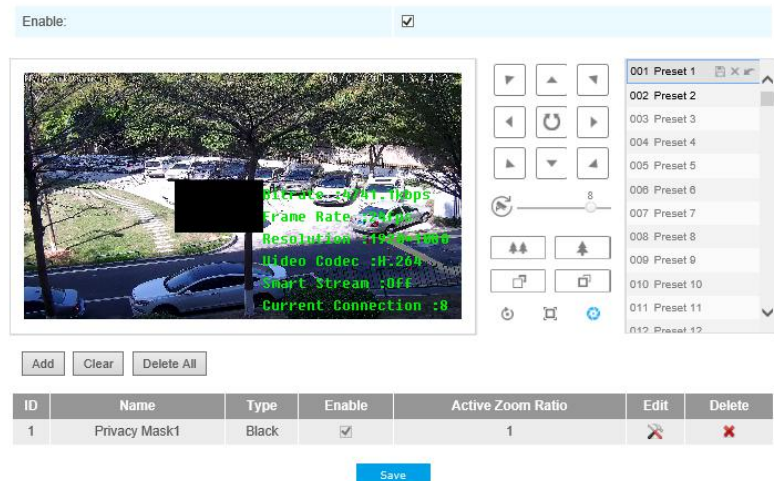

Table 4-5-19 Description of the buttons

Parameters	Function Introduction
Enable	Check the checkbox to enable the Privacy Mask function
Add	Add the current drawing area as Privacy Mask
Clear	Clear the current drawing area
Clear All	Clear all areas you drew before
Name	Support to customize the name of Privacy Mask
Type	Select the color for the privacy areas, there are eight colors available: White, Black, Blue, Yellow, Green, Brown, Red, Violet

Active Zoom Ratio

Set the value of Active Zoom Ratio according to your need, and then the mask will only appear when the zoom ratio is greater than the predefined value

Scheduled Tasks

You can configure the PTZ camera to perform a certain action automatically in a user-defined time period.

Step1: Enter the Scheduled Task Settings interface:

Enable Scheduled Tasks:

Schedule Settings

Close

Sun 0 2 4 6 8 10 12 14 16 18 20 22 24

Mon 0 2 4 6 8 10 12 14 16 18 20 22 24

Tue 0 2 4 6 8 10 12 14 16 18 20 22 24

Wed 0 2 4 6 8 10 12 14 16 18 20 22 24

Thu 0 2 4 6 8 10 12 14 16 18 20 22 24

Fri 0 2 4 6 8 10 12 14 16 18 20 22 24

Sat 0 2 4 6 8 10 12 14 16 18 20 22 24

Close
Auto Scan
Preset
Patrol
Pattern
Check

Tasks Interference Settings

Tasks Recovery Time(5-720s): s

Step2: Check the checkbox to Enable Scheduled Task.

Step3: Set the schedule and task details.

Step4: Set the Task Recovery Time(from 5 to 720 seconds). You can set the time(a period of inactivity) before the PTZ camera starts the schedule and task details.

Step5: Click button to save all the configurations.

Note:

- 1) The time of each task cannot be overlapped. Up to 10 tasks can be configured for each day.
- 2) The Scheduled Tasks function is prior to Auto Home function. When these two functions are set at the same time, only the Scheduled Tasks function takes effect.

- 1) You can click button to select or close all schedule of different kinds of tasks.

Auto Tracking

PTZ series cameras support to track the moving objects automatically after you configure this function.

Enable:	<input type="checkbox"/>
Show Tracking:	<input type="checkbox"/>
Sensitivity:	<input type="text" value="5"/>
Max. Tracking Time	<input type="text" value="30"/> s

[Save](#)

Step1: Check the checkbox to enable Auto Tracking;

Step2: Enable “Show Tracking” to show tracking in Auto Tracking function.

Step3: Set detecting sensitivity;

Step4: Set Max. Tracking Time which must be between 5~300s. The camera will stop tracking when the tracking time is used up.

Note: Please turn off Auto Home before using Auto Tracking.

Config Clear

Clear All:	<input type="checkbox"/>
Clear All Presets:	<input type="checkbox"/>
Clear All Patrols:	<input type="checkbox"/>
Clear All Patterns:	<input type="checkbox"/>
Clear All Auto Homes:	<input type="checkbox"/>
Clear All PTZ Limits:	<input type="checkbox"/>
Clear Initial Position:	<input type="checkbox"/>
Clear All Privacy Masks:	<input type="checkbox"/>
Clear All Scheduled Tasks:	<input type="checkbox"/>

[Save](#)

Here you can clear PTZ configurations, including all PTZ configurations, Presets, Patrols, Patterns, Auto Homes, PTZ Limits , Initial Position(Mini PTZ Bullet), Privacy Masks and Scheduled Tasks.

RS485

Protocol:	<input checked="" type="radio"/> Pelco-D <input type="radio"/> Pelco-P
Baudrate:	9600
Data Bit:	8
Stop Bit:	1
Parity:	None
Flow Control:	None
PTZ Address:	1

[Save](#)

Here you can clear configure RS485 serial port to control the PTZ of Speed Dome. Protocol, Baudrate, Data Bit, Stop Bit, Parity, Flow Control, PTZ Address should be exactly the same as those of the control device.

Note:

This function is only for Speed Dome.

4.5.7 LPR(Optional)

The LPR function will automatically detects and captures license plate in real time and compares to a predefined list, then takes appropriate action such as generating an alert once the license plate is on the predefined black list.

Note:

(1) LPR is optional for 12x AF Motorized Pro Bullet, Mini PoE PTZ Bullet, ABF Pro Box, Vandal-proof Motorized Mini Bullet, Motorized Pro Bullet Network Camera.

(2) Currently we have three LPR versions, **LPR1, LPR2 and LPR3**. LPR1 is for Asian regions, LPR2 is for European regions and the former Soviet Union and LPR3 is for Korea.

For more information, please refer to ***Milesight-Troubleshooting-LPR setting-LPR1, Milesight-Troubleshooting-LPR setting-LPR2, Milesight-Troubleshooting-LPR setting-Korea.***

Settings

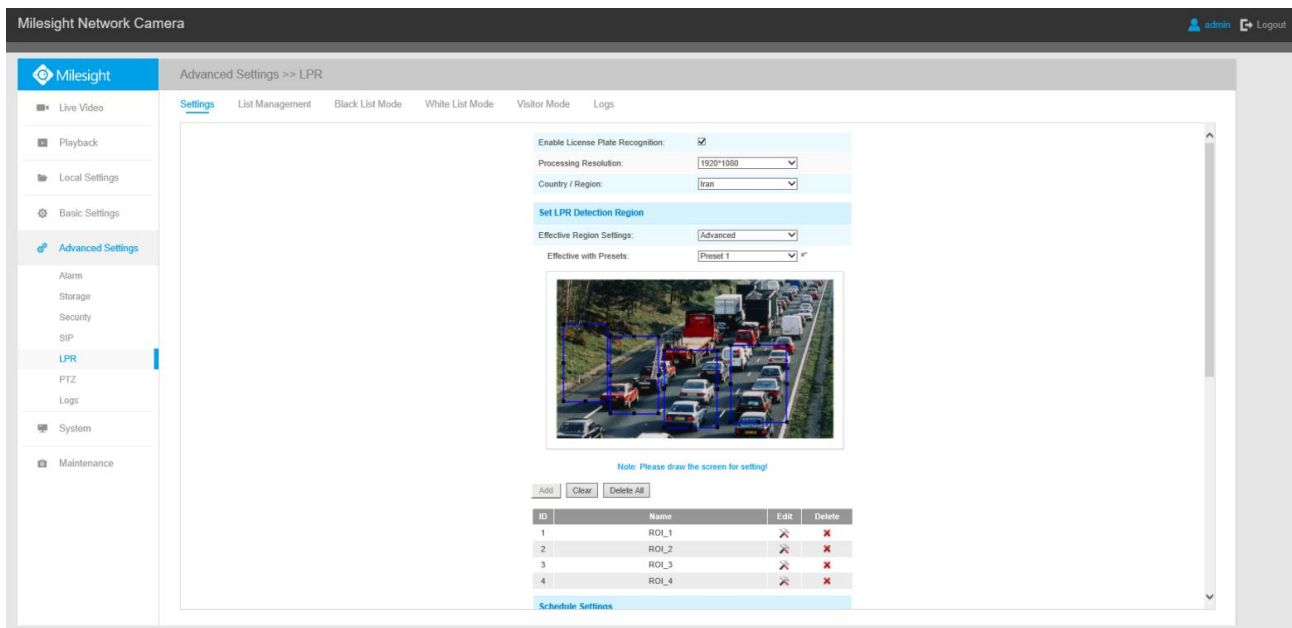

Step1: Enter the license and click Save. When the License Status changes to Valid, the camera can start detecting the license plate.

Enable License Plate Recognition:	<input checked="" type="checkbox"/>
License:	7325220EC7B6C181B38A
License Status:	Valid
Processing Resolution:	1280*720

Note: Only LPR2 and LPR3 need to enter a license to activate the LPR function.

Step2: Check the checkbox “Enable License Plate Recognition”, you can draw the screen to select area interested.

Table 4-5-20 Description of the buttons

Parameters	Function Introduction
License (Only for LPR2 and LPR3)	Generated by camera’s information
License Status (Only for LPR2 and LPR3)	Show present license status, including Valid, Invalid .
Processing Resolution	Resolution of the stream for LPR analysis, including 1920*1280, 1280*720, 640*360, 320*176.
Country/ Region (Only for LPR1)	Select country/ region to detect the license plate.
Effective Region Settings (Only for PTZ series)	Normal: configure the LPR detection regions for the current area. Advanced: configure different LPR detection regions for different PTZ presets(Only support Preset 1~4 so far).
Enable Day/Night Detection Mode	With this option enabled, the camera will enable different detection modes according to Day/Night mode.

<p>(Only for LPR3)</p>																					
<p>Enable Vehicle Speed Detection (Only for LPR3)</p>	<p>With this option enabled, the camera will detect the vehicle speed and display the result on the logs interface.</p> <p>You need to draw two lines(Line1 and Line2) on the live view, and fill in Camera Installation Height, Horizontal Distance1 and Horizontal Distance2, camera will combine the line you draw and the data filled to calculate the vehicle speed.</p> <p>Camera Installation Height: real height of camera.</p> <p>Horizontal Distance1: real distance between camera pole and line1.</p> <p>Horizontal Distance2: real distance between camera pole and line2.</p> <div data-bbox="542 609 1372 958"> <h3>Speed of vehicle</h3> <ul style="list-style-type: none"> Requirement <ul style="list-style-type: none"> Real height of camera (H) (unit: meter) Real distance between camera pole and line (d1, d2) (unit: meter) Pixel position of each line (y1, y2) (unit: pixel) To be changed UI <ul style="list-style-type: none"> Drawable two lines Edit boxes to input camera height and distance of each line </div>																				
<p>Add</p>	<p>Draw the screen to select the area interested, then click "Add" button to add the area,only four recognition areas can be added.</p> <p>You can edit the name of the area or delete the area in the list below.</p> <table border="1" data-bbox="558 1115 1356 1326"> <thead> <tr> <th>ID</th> <th>Name</th> <th>Edit</th> <th>Delete</th> </tr> </thead> <tbody> <tr> <td>1</td> <td>ROI_1</td> <td></td> <td></td> </tr> <tr> <td>2</td> <td>ROI_2</td> <td></td> <td></td> </tr> <tr> <td>3</td> <td>ROI_3</td> <td></td> <td></td> </tr> <tr> <td>4</td> <td>ROI_4</td> <td></td> <td></td> </tr> </tbody> </table> <p>Note: Only license plates larger than 150 pixels can be recognized.</p>	ID	Name	Edit	Delete	1	ROI_1			2	ROI_2			3	ROI_3			4	ROI_4		
ID	Name	Edit	Delete																		
1	ROI_1																				
2	ROI_2																				
3	ROI_3																				
4	ROI_4																				
<p>Clear</p>	<p>Click the "Clear" button to clear the area being drawn.</p>																				
<p>Delete All</p>	<p>Click the "Delete All" button to delete all the added areas.</p>																				

Step3: Schedule Settings. You can draw the schedule by clicking Edit button.



Step4: Set Detection Settings and LPR Message Post Settings.

The figure shows two configuration panels. The top panel, 'Detection Settings', includes:

- Detection Trigger: Always (dropdown)
- Confidence Level: A slider set to 4
- Repeat Plate Checktime: 0 minute (dropdown), with a note '(0~60min)'
- Features Identification: Checkboxes for All, Region, Direction, and ROI_ID.

 The bottom panel, 'LPR Message Post Settings', includes:

- Enable LPR Message Post: Checked checkbox
- Post Type: RTSP (dropdown)

Table 4-5-21 Description of the buttons

Parameters	Function Introduction
Detection Trigger	<p>Always: in this mode, camera will always detect the license plate.</p> <p>Alarm Input: in this mode, camera will only detect the license plate during Alarm Input is being triggered.</p>
Confidence Level (Only for LPR1 and LPR2)	<p>You can set the confidence level from 1 to 10.</p> <p>When the confidence level of the license plate is higher than the set confidence level, it will push the license plate image to the logs interface.</p>
Repeat Plate Checktime	<p>Set the time interval for repeatedly reading license plates to effectively avoid duplicate identification of parking vehicles.</p> <p>You can set Repeat Plate Checktime from 0 to 60min or 0 to 60000ms.</p>
Feature Identification	<p>Check Region(Only for LPR2), ROI_ID, Direction or All to enable Features Identification, it will display the corresponding information on the logs interface.</p>
Enable LPR Message Post	<p>Check the checkbox to enable LPR Message Post. It will push information to some third-party devices or softwares that are compatible with ours.</p>

Post Type	Information can be pushed by RTSP, TCP or HTTP .
------------------	---

List Management

Add the license plates to this interface as Black or White type (Black/White List), and then you can set the alarm action for these license plates in the corresponding black list mode or white list mode interface. When these license plates are detected, the camera will respond accordingly to your settings.

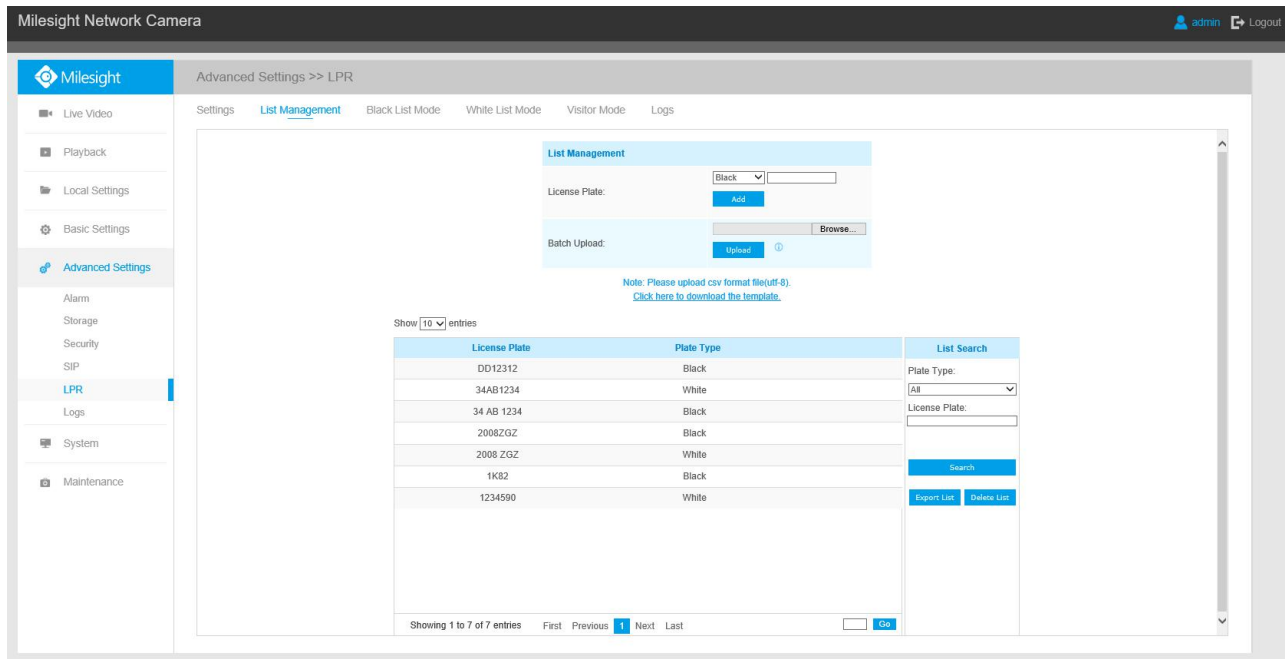
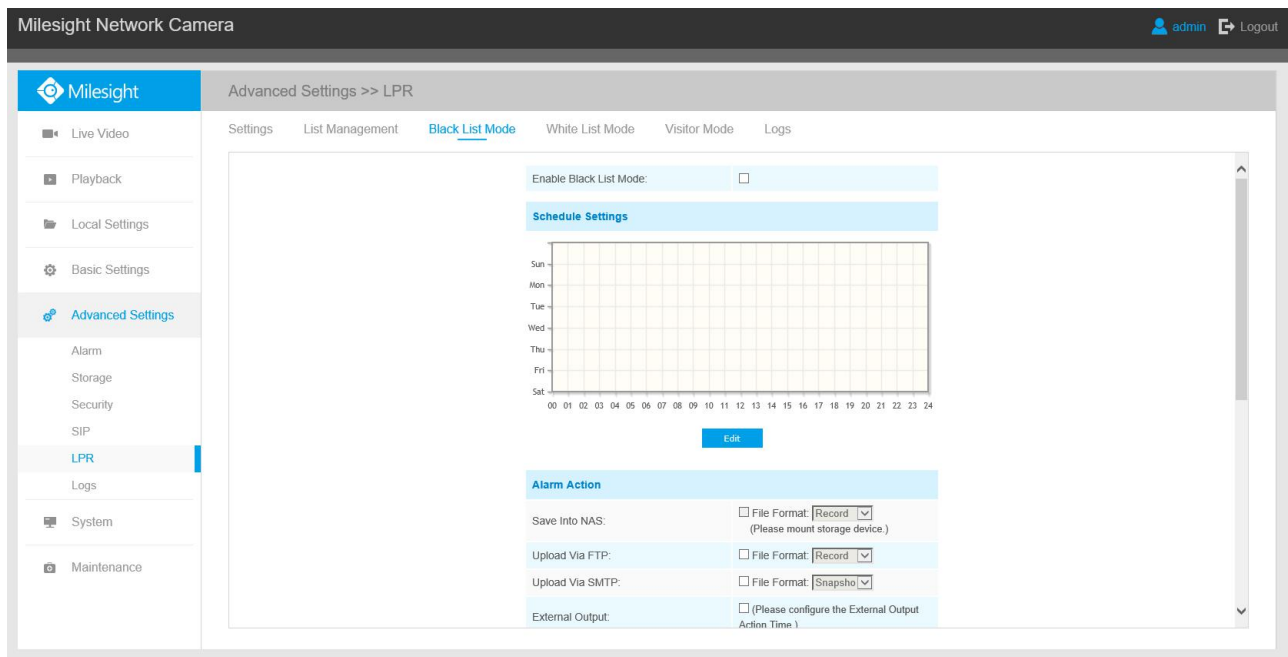

Table 4-5-22 Description of the buttons

Parameters	Function Introduction
Add License Plate	Select the license plate type as black or white, enter the license plate, click the "Add" button, the license plate will be added successfully.
Batch Upload	You can add a csv form with the license plate you want to add, click the "Browse" button to import the form to this interface, click the "Upload" button, the license plates will be added successfully. Note: You can first download the template as a reference in this interface.
List Search	Select Plate Type or directly enter the license plate number, click the "Search" button, the corresponding license plate will be displayed in the list below.
Export List	Click the "Export List" button to export the license plate in the current list to a csv form locally.
Delete List	Click the "Delete List" button to delete all the license plate in the current list.

Note: It supports adding 1000 Black List and White List.

Black List Mode



Step1: Check the checkbox to enable Black List Mode.

Step2: Schedule Settings. You can draw the schedule by clicking Edit button.

Step3: Set alarm action.

Alarm Action	
Save Into NAS:	<input type="checkbox"/> File Format: Record (Please mount storage device.)
Upload Via FTP:	<input type="checkbox"/> File Format: Record
Upload Via SMTP:	<input type="checkbox"/> File Format: Snapsho
External Output:	<input type="checkbox"/> (Please configure the External Output Action Time.)
Play Audio:	<input type="checkbox"/> (Please configure the Audio Action Settings and Audio Interval.)
Alarm to SIP Phone:	<input type="checkbox"/> (Please open the SIP.)
HTTP Notification:	<input type="checkbox"/>

Step4: Set alarm settings.

Alarm Setting	
Record Video Sections:	5 seconds
Pre-record:	0 second
Snapshot Type:	License Plate
Snapshot:	3
Snapshot Interval:	1 second
External Output Action Time:	30 seconds
Audio Action Settings:	Edit
Play Audio Interval:	Auto

After that, when a license plate marked as “black” is detected, the camera will respond accordingly to your settings.

White List Mode

Step1: Check the checkbox to enable White List Mode.

Step2: Schedule Settings. You can draw the schedule by clicking Edit button.

Step3: Set alarm action.

Alarm Action	
Save Into NAS:	<input type="checkbox"/> File Format: Record (Please mount storage device.)
Upload Via FTP:	<input type="checkbox"/> File Format: Record
Upload Via SMTP:	<input type="checkbox"/> File Format: Snapsho
External Output:	<input type="checkbox"/> (Please configure the External Output Action Time.)
Play Audio:	<input type="checkbox"/> (Please configure the Audio Action Settings and Audio Interval.)
Alarm to SIP Phone:	<input type="checkbox"/> (Please open the SIP.)
HTTP Notification:	<input type="checkbox"/>

Step4: Set alarm settings.

Alarm Setting	
Record Video Sections:	5 seconds
Pre-record:	0 second
Snapshot Type:	License Plate
Snapshot:	3
Snapshot Interval:	1 second
External Output Action Time:	30 seconds
Audio Action Settings:	Edit
Play Audio Interval:	Auto

After that, when a license plate marked as “White” is detected, the camera will respond accordingly to your settings.

Visitor Mode

Step1: Check the checkbox to enable Visitor Mode.

Step2: Schedule Settings. You can draw the schedule by clicking Edit button.

Step3: Set alarm action.

Alarm Action	
Save Into NAS:	<input type="checkbox"/> File Format: Record (Please mount storage device.)
Upload Via FTP:	<input type="checkbox"/> File Format: Record
Upload Via SMTP:	<input type="checkbox"/> File Format: Snapsho
External Output:	<input type="checkbox"/> (Please configure the External Output Action Time.)
Play Audio:	<input type="checkbox"/> (Please configure the Audio Action Settings and Audio Interval.)
Alarm to SIP Phone:	<input type="checkbox"/> (Please open the SIP.)
HTTP Notification:	<input type="checkbox"/>

Step4: Set alarm settings.

Alarm Setting	
Record Video Sections:	5 seconds
Pre-record:	0 second
Snapshot Type:	License Plate
Snapshot:	3
Snapshot Interval:	1 second
External Output Action Time:	30 seconds
Audio Action Settings:	Edit
Play Audio Interval:	Auto

After that, when a license plate that is not marked as "Black" or "White" is detected, the camera will respond accordingly to your settings.

Logs

Time	License Plate	Plate Type
2019-09-18 14:40:00	EV309JU	Visitor
2019-09-18 14:43:42	EV309JU	Visitor
2019-09-18 14:43:21	EV309JU	Visitor
2019-09-18 14:39:14	EV309JU	Visitor
2019-09-18 14:34:48	EV309JU	Visitor
2019-09-18 14:32:36	EV309JU	Visitor
2019-09-18 14:20:47	EV309JU	Visitor
2019-09-18 14:19:45	EV309JU	Visitor
2019-09-18 14:19:06	EV309JU	Visitor
2019-09-18 14:18:55	EV309JU	Visitor
2019-09-18 14:18:50	EV309JU	Visitor
2019-09-18 14:13:35	EV309JU	Visitor
2019-09-18 14:12:40	EV309JU	Visitor
2019-09-18 14:11:11	EV309JU	Visitor
2019-09-18 13:18:01	EV309JU	Visitor

The detect results in real time will be displayed on the right side of Logs page, including detected time, live screenshot, and license plate.

Note: Only 10 logs are visible on the right side.

Time	Snapshot	License Plate
2019-03-14 14:48:57		34AB1234
2019-03-14 14:48:56		34AB1234
2019-03-14 14:48:55		34AB1234
2019-03-14 14:48:54		34AB1234

Select Plate Type or directly enter the license plate number, select Start Time and End Time, click the "Search" button, the corresponding license plate will be displayed in the list below.

Note: It supports displaying 10,000 logs.

Show entries

Time	License Plate	Plate Type	
2019-09-18 14:48:00	EV309JO	Visitor	
2019-09-18 14:43:42	EV309JO	Visitor	
2019-09-18 14:43:21	EV309JO	Visitor	
2019-09-18 14:39:14	EV309JO	Visitor	
2019-09-18 14:34:48	EV309JO	Visitor	Detail
2019-09-18 14:32:36	EV309JO	Visitor	
2019-09-18 14:20:47	EV309JO	Visitor	
2019-09-18 14:19:45	EV309JO	Visitor	
2019-09-18 14:19:06	EV309JO	Visitor	
2019-09-18 14:18:55	EV309JO	Visitor	
2019-09-18 14:18:50	EV309JO	Visitor	
2019-09-18 14:13:35	EV309JO	Visitor	
2019-09-18 14:12:48	EV309JO	Visitor	
2019-09-18 14:11:11	EV309JO	Visitor	
2019-09-18 13:18:01	EV309JO	Visitor	
2019-09-18 11:35:41	TB696N	Visitor	

Showing 1 to 30 of 396 entries First Previous **1** 2 3 4 5 ... 14 Next Last

Log Search

Plate Type:

License Plate:

Start Time:

End Time:

Click on the "Detail" button to the right of each log to display license plate details as shown below.

Milesight Network Camera ✕

License Plate Details

Time:	License Plate:	Plate Type:	ROI_ID:
2019-09-20 11:08:57	۲۴۲۶۴۲۸۱	Visitor	1
Direction:	-		

LPR1



LPR2

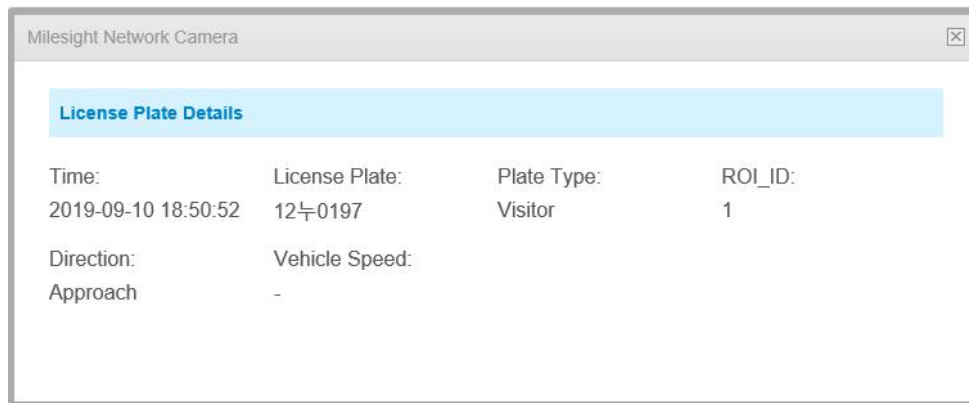

LPR3

Click the "Log Export" button to export the license plate in the current list to a csv form locally. You can also click the "Auto Export" button to automatically export the log to FTP, SMTP or Storage.

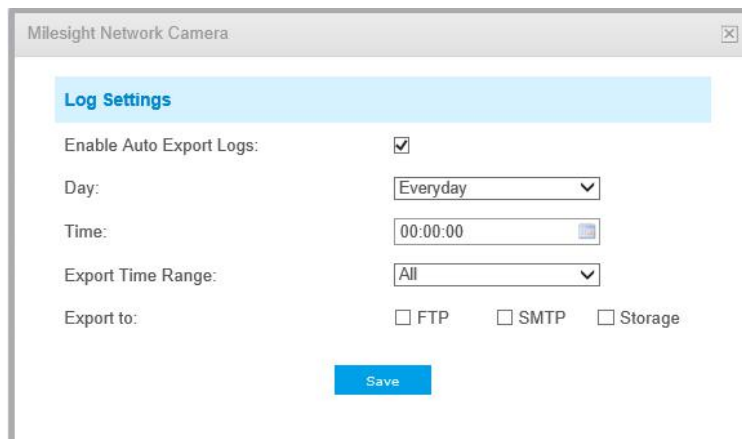

4.5.8 Logs

The logs contain the information about the time and IP that has accessed the camera through web.

Show entries

Time	Main Type	Sub Type	Param	User	IP	Detail	Log Search
2017-09-04 13:35:41	Operation	RTSP Session Stop	-	-	192.168.8.50	stop one session.	Main Type: <input type="text" value="All Types"/> Sub Type: <input type="text" value="All Types"/> Start Time: <input type="text" value="2017-09-04 00:00:00"/> End Time: <input type="text" value="2017-09-04 13:30:26"/> <input type="button" value="Search"/> <input type="button" value="Log Export"/> Save Period: <input type="text" value="Permanent"/> <input type="button" value="Save"/>
2017-09-04 13:29:18	Operation	RTSP Session Start	-	-	192.168.8.50	start one session.	
2017-09-04 13:29:14	Operation	RTSP Session Stop	-	-	192.168.8.50	stop one session.	
2017-09-04 13:28:54	Operation	RTSP Session Start	-	-	192.168.8.50	start one session.	
2017-09-04 13:28:53	Operation	Login Remotely	-	admin	192.168.8.50	-	
2017-09-04 05:50:00	Information	IR-CUT On	-	-	-	-	
2017-09-03 18:35:25	Information	IR-CUT Off	-	-	-	-	
2017-09-03 05:43:58	Information	IR-CUT On	-	-	-	-	
2017-09-02 18:37:57	Information	IR-CUT Off	-	-	-	-	
2017-09-02 05:41:22	Information	IR-CUT On	-	-	-	-	
2017-09-01 18:43:37	Information	IR-CUT Off	-	-	-	-	
2017-09-01 17:00:57	Operation	RTSP Session Stop	-	-	192.168.8.50	stop one session.	
2017-09-01 16:55:24	Event	Motion Detection Stop	-	-	-	-	
2017-09-01 16:55:19	Operation	RTSP Session Start	-	-	192.168.8.50	start one session.	
2017-09-01 16:55:17	Operation	RTSP Session Stop	-	-	192.168.8.50	stop one session.	

Showing 1 to 30 of 1,221 entries First Previous **1** 2 3 4 5 ... 41 Next Last

Table 4-5-23 Description of the buttons

Parameters	Function Introduction
Main Type	There are five main log types: All Type , Event , Operation , Information , Exception .
Sub Type	On the premise that main type has been selected, select the sub type to narrow the range of logs.
Start Time	The time log starts
End Time	The time log ends
Log Export	Export the logs
Save Period	Set the period of log saving. There are eight options to choose: Permanent and 30/60/120/180/240/300/360 Days .
Go	Input the number of logs' page.

4.6 System

All information about the hardware and software of the camera can be checked on this page.

System	
Device Name:	Network Camera
Product Model:	MS-C4461-EB
Hardware Version:	V1.1
Software Version:	41.7.0.72
MAC Address:	1C:C3:16:21:C5:84
Device Information:	SE010E5270N3
Alarm Input:	1
Alarm Output:	1
Uptime:	21 hours 6 minutes

Table 4-6-1 Description of the parameters

Parameters	Function Introduction
Device Name	The device name can be customized. It will be seen in file names of video files.
Product Model	The product model of the camera
Hardware Version	The hardware version of the camera
Software Version	The software version of the camera can be upgraded
MAC Address	Media Access Control address
Device Information	The device information, including information about alarm I/O and clipper chip
Alarm Input	The number of Alarm Input interface
Alarm Output	The number of Alarm Output interface
Uptime	The elapsed time since the last restarted of the device

Note:

The Alarm Input/Alarm Output will appear only when the camera have alarm input/output interface.

4.7 Maintenance

4.7.1 System Maintenance

The software can be upgraded by the following steps:

Step1: Browse and select the upgrading file;

Step2: Click the “upgrade” button after it prompts upload file successfully. After the system reboots successfully, the update is done.

Note:

Do not disconnect the power of the device during the update. The device will be restarted to complete the upgrading.

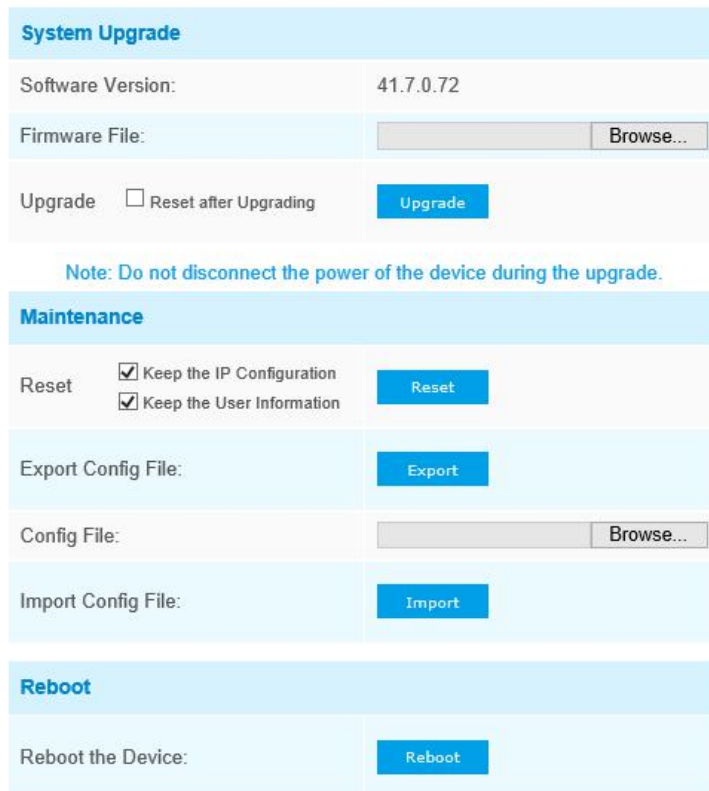

The screenshot shows a web interface with three main sections: **System Upgrade**, **Maintenance**, and **Reboot**.
System Upgrade section includes: Software Version: 41.7.0.72; Firmware File: [Browse...]; Upgrade: Reset after Upgrading; [Upgrade] button.
Maintenance section includes: Reset: Keep the IP Configuration, Keep the User Information; [Reset] button; Export Config File: [Export] button; Config File: [Browse...]; Import Config File: [Import] button.
Reboot section includes: Reboot the Device: [Reboot] button.

Table 4-7-1 Description of the buttons

Parameters	Function Introduction
System Upgrade	<p>Software Version: The software version of the camera</p> <p>Firmware File: Select the firmware used to upgrade</p> <p>Reset after Upgrading: Check this option to reset the camera after upgrading it</p>
Maintenance	<p>Reset settings: Click “Reset” button to reset the camera to factory default settings</p> <p>Keep the IP Configuration: Check this option to keep the IP configuration when resetting the camera.</p> <p>Keep the User information: Check this option to keep the user information when resetting the camera.</p> <p>Export Config File: Click this button to export the configuration file</p> <p>Import Config File: Click this button to import the old configuration file</p>
Reboot	Click “Reboot” button to restart the device immediately

4.7.2 Auto Reboot

Set the date and time to enable Auto Reboot function. The camera will reboot automatically according to the customized time in case that camera overload after running a long time.

Auto Reboot Settings	
Enable Auto Reboot:	<input type="checkbox"/>
Day:	Everyday ▼
Time:	00:00:00 🕒

[Save](#)

Chapter V Services

Milesight Technology Co., Ltd provides customers with timely and comprehensive technical support services. End-users can contact your local dealer to obtain technical support. Distributors and resellers can contact directly with Milesight for technical support.

Technical Support Mailbox: support@milesight.com

Web: <http://www.milesight.com>

Online Problem Submission System: <http://www.milesight.com/service/feedback.asp>

MILESIGHT USA

TEL: +1-800-561-0485

Add: 220 NE 51st ST Oakland Park, FL 33334, USA

MILESIGHT KOREA

TEL: +82-2-839-3335

Add: 925, Anyang SK V1 Center, LS-ro 116beon-gil, Dongan-gu, Anyang-si, Korea

MILESIGHT CHINA

TEL: +86-592-5922772

Add: No.23 Wanghai Road,2nd Software Park, Xiamen, China

Milesight
Better Inside, More in Sight